

# NOVAR 24xx

## Three-Phase Power Factor Controllers & Multimeters

*Operating Manual*

*Firmware v. 1.0.0.3140*

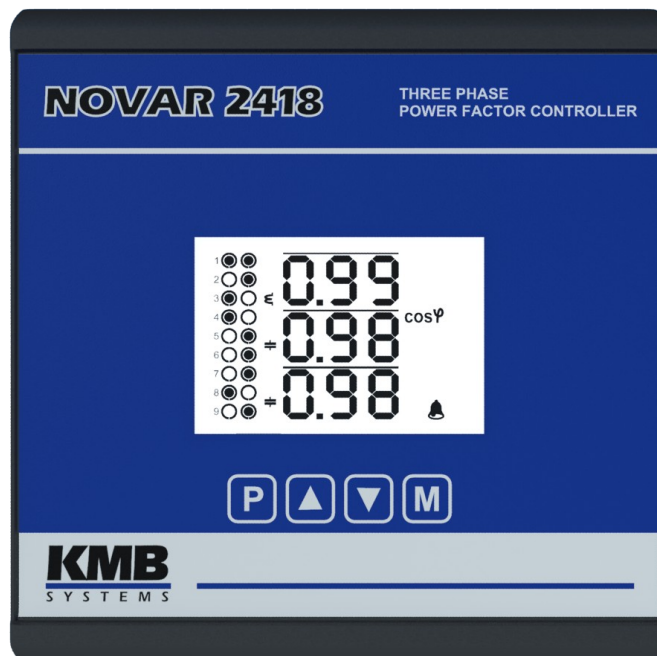

# LIST OF CONTENTS

<b>1. GENERAL.....</b>	<b>5</b>
1.1 Common features.....	5
1.2 Operation.....	6
<b>2. INSTALLATION.....</b>	<b>9</b>
2.1 Physical.....	9
<b>2.2 Instrument Connection.....</b>	<b>9</b>
2.2.1 Power Supply.....	9
2.2.2 Measured Electrical Quantities.....	10
2.2.2.1 Measured Voltages.....	10
2.2.2.2 Measured Currents.....	10
2.2.3 Relay Outputs.....	10
2.2.4 Digital Input.....	11
<b>3. COMMISSIONING.....</b>	<b>12</b>
<b>3.1 Setup.....</b>	<b>12</b>
3.1.1 Measured Electrical Quantities Installation Setup.....	13
3.1.1.1 Setup Example.....	13
3.1.2 PFC Setup.....	14
3.1.2.1 PFC Control Setup.....	14
3.1.2.2 PFC Output Setup.....	15
3.1.2.3 AOR-Process.....	15
<b>4. DETAILED DESCRIPTION.....</b>	<b>17</b>
<b>4.1 Basic Functions.....</b>	<b>17</b>
<b>4.2 Measured Data &amp; Status Presentation.....</b>	<b>17</b>
4.2.1 Measured Data Screen.....	18
4.2.2 Average Values.....	20
4.2.3 Full Spectrum Values P/Q/PF & Fundamental Harmonic Values Pfh/Qfh/cosφ.....	21
4.2.4 Fundamental Harmonic Power Factor Formats cosφ/tanφ/φ.....	21
4.2.5 Deviation Flags.....	22
4.2.6 THDs, CHL and Harmonics.....	22
4.2.7 Electricity Meter.....	23
4.2.7.1 “4E+Pmax” Display Mode .....	23
4.2.7.2 “8E” Display Mode .....	24
4.2.8 Outputs State.....	24
4.2.9 State Indicators.....	25
4.2.9.1 Main Operating States.....	25
4.2.9.2 Alarm.....	25
4.2.9.3 Active Power Export.....	25
4.2.9.4 Digital Input State.....	25
4.2.9.5 Instrument Setup Indicator.....	25

<b>4.3 Setup Parameters.....</b>	<b>26</b>
4.3.1 Parameter Checking & Editing.....	26
4.3.1.1 Side Branch Parameters.....	26
4.3.2 General Meter Parameters.....	28
4.3.2.1 Instrument Lock – Parameter No. 00.....	28
4.3.2.2 Backlight Parameter, No. 80.....	29
4.3.2.3 Other Parameters.....	29
4.3.3 PFC Control Parameters.....	30
4.3.3.1 Target Power Factor for Tariff 1/2, Parameter No. 01/06.....	30
4.3.3.2 Control Bandwidth on High Loads for Tariff 1/2, No. 01/06.....	31
4.3.3.3 Control Time for Tariff 1/2, No. 02/07.....	31
4.3.3.4 Offset Power for Tariff 1/2, No. 03/08.....	32
4.3.3.5 Tariff 2 Control, No. 05.....	32
4.3.3.6 Tariff 2 Control Power, No. 10.....	33
4.3.3.7 Control Strategy, No. 11.....	33
4.3.3.8 Choke Control & Choke Control Limit Power Factor, No. 12.....	34
4.3.3.8.1 Mixed Choke Control.....	34
4.3.3.8.2 Choke Control Limit Power Factor (for Mixed Choke Control).....	35
4.3.3.8.3 Non-Mixed Choke Control.....	35
4.3.3.9 Offset Control, No. 13.....	35
4.3.4 PFC Output Parameters.....	37
4.3.4.1 Automatic Output Recognizer (AOR) Launch, No. 20.....	37
4.3.4.2 Manual Output Type & Power Filler, No. 21.....	38
4.3.4.3 Output Type & Nominal Power, No. 25.....	39
4.3.4.4 Output Control State, No. 26.....	40
4.3.4.5 Output Switch Count & Switch-On Time, No. 27, 28.....	40
4.3.4.6 Fan / Heater Temperature Thresholds, No. 29 ÷31.....	40
4.3.4.7 Output Set 2, No. 33.....	41
4.3.4.8 Discharge Time for Output Set 1 / 2, No. 34.....	41
4.3.4.9 Switching Mode, No. 35.....	42
4.3.5 PFC Alarm Parameters.....	42
4.3.5.1 Standard Type Alarms.....	45
4.3.5.2 Fast Actuation Reaction Alarms.....	45
4.3.5.3 NS> - “Number of Switching Operations Exceeded” Alarm.....	46
4.3.5.4 OE - “Output Error” Alarm.....	46
4.3.5.5 T1>< (T2><) - “Temperature Exceeded/Drop” Alarm.....	47
4.3.5.6 OoC - “Out of Control” Alarm.....	47
4.3.5.7 RCF - “Remote Control Failure” Alarm.....	48
<b>4.4 Instrument Operation.....</b>	<b>48</b>
4.4.1 Control State.....	49
4.4.1.1 Control Time, Parameter No. 65.....	49
4.4.2 Standby State, Standby Cause Parameter No. 66.....	50
4.4.3 Manual State.....	50
4.4.4 Automatic Output Recognition (AOR) Process, Parameter No. 20.....	51
4.4.5 CT Connection Test, Parameter No. 81.....	53
4.4.6 Manual Intervention in Control Process.....	55
4.4.7 Power Factor Block Factory Setting.....	55
<b>4.5 Method of Measurement.....</b>	<b>56</b>
4.5.1 Voltage Fundamental Frequency Measurement Method.....	56
4.5.2 Voltage and Current Measurement Method.....	56
4.5.3 Harmonics and THD Evaluation Method.....	57
4.5.4 Power, Power Factor and Unbalance Evaluation Method.....	58
4.5.5 Temperature.....	59
<b>4.6 Measured Values Evaluation and Aggregation.....</b>	<b>59</b>
4.6.1 Actual Values Evaluation and Aggregation.....	60
4.6.2 Average Values Evaluation.....	60

4.6.3 Embedded Electricity Meter.....	61
4.6.3.1 Electric Energy Processing.....	61
4.6.3.2 Maximum Active Power Demand Registration.....	61
<b>4.7 Special PFC-Block Related Quantities' Meaning &amp; Method of Evaluation.....</b>	<b>61</b>
4.7.1 $\Delta Q_{fh}$ – PF Control Deviation.....	61
4.7.2 CHL – Capacitor Harmonic Load Factor.....	62
4.7.3 RC, RL – Compensation Reserve Powers.....	64
<b>5. COMPUTER CONTROLLED OPERATION.....</b>	<b>66</b>
<b>5.1 Communication Interface.....</b>	<b>66</b>
5.1.1 RS-485 Interface.....	66
5.1.1.1 Communication Cable.....	66
5.1.1.2 Terminating Resistors.....	66
5.1.2 Ethernet (IEEE802.3) Interface.....	66
<b>5.2 Communication Protocols.....</b>	<b>67</b>
5.2.1 KMB Communications Protocol.....	67
5.2.2 Modbus Communications Protocol.....	67
<b>5.3 The ENVIS Program.....</b>	<b>67</b>
<b>6. EXAMPLES OF CONNECTIONS.....</b>	<b>68</b>
<b>7. MANUFACTURED MODELS AND MARKING.....</b>	<b>73</b>
<b>8. TECHNICAL SPECIFICATIONS.....</b>	<b>74</b>
<b>9. MAINTENANCE, SERVICE.....</b>	<b>78</b>

# 1. General

The NOVAR 24xx ( the “xx” means arbitrary codes) are the next models of the NOVAR 2xxx line power factor controllers. Similarly as more advanced NOVAR 26xx models, they are based on precise and powerful three-phase measurement & evaluating core and combine multifunctional panel meter with power factor control functionality in the same box.

For on-line monitoring, the controllers can be provided with remote communication interface.

The controllers can be delivered with various numbers of outputs & inputs and communication interfaces.

## 1.1 Common features

### Power Factor Control

- individual phase power factor control capability using single- / two- / three-phase capacitors and chokes
- selectable power factor control strategy : both three- and single-phase control / three-phase control only / three independent single-phase controls
- up to 18 output sections, relay or solid-state
- controller’s speed of response independently programmable for conditions of undercompensation and overcompensation
- the preset speed of response increases in proportion to instantaneous control deviation, that is either with the value squared or in direct proportion to the ratio of the control deviation to the smallest section value ( $O_{MIN}$ )
- adjustable control range to reduce the number of control interventions in systems with a wide control range at high loads
- combined mains compensation & decompensation capability
- selectable two-rate operation controlled with active power level or external signal (optional input)
- automatic output section recognition, any combination of the output sections possible
- continuously checks output sections in the control process. When failure is detected repeatedly, disables the faulty section and possibly actuates alarm.
- periodically rechecks the temporarily disabled sections and on positive test result (for example when replacing a section’s burnt fuse link), it enables them again automatically
- wide assortment of independently settable alarm’s warning and actuation functions ( undervoltage, overvoltage, undercurrent, overcurrent, THDU limit overflow and more )

### Measurement & Evaluation

- three measurement wide range voltage inputs, star / delta / Aron connection
- three measurement current inputs for xxx/ 5A or xxx /1A CTs connection
- sampling rate 128/96 samples/period, 10/12 periods evaluation cycle (200 ms at 50/60 Hz)
- continuous ( gap-less) measurement of voltage and current
- evaluation of harmonic components up to 40<sup>th</sup>
- fixed window / floating window / thermal average values of all evaluated quantities with minimum & maximum values registration
- built-in electricity meter :
  - four-quadrant three tariff electricity meter
  - single phase and three phase energies
  - maximum of average active power value ( power demand )

- built-in thermometer

### Design

- 144x144 mm plastic box for panel mounting
- LCD -FSTN segment display, 4 keys
- digital input ( 2607/2616 models only )

### Communication

- optional remote communication interface ( RS 485 / Ethernet )
- proprietary protocol with free data acquisition software ENVIS
- MODBUS RTU and MODBUS TCP protocols for simple integration with third party SCADA software

## 1.2 Operation

From point of view of function the NOVAR 24xx-line power factor controllers consist from two main blocks.

The first of them is universal three-phase meter. The meter can be optionally equipped with a communication interface.

The second part of the instrument is power factor control block. The block uses measured data from the meter block; except of this, both of the blocks operate autonomously.

NOVAR 24xx Block Diagram

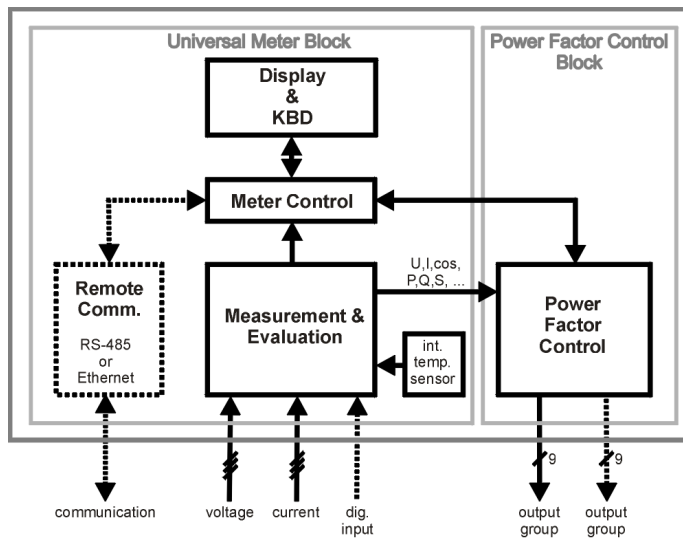

After an activation of supply voltage, the instrument accomplishes internal diagnostics and then it starts to measure and display actual measured data. Simultaneously, the power factor control blocks starts and tries to keep power factor as near as possible to the preset value by connecting optimal combination of compensation elements to the network.

Most of actual measured and evaluated data can be observed on the instrument's display. Navigation through the screens is intuitive with arrow keys. The data are arranged in row of screens according navigation maps below.

NOVAR 24xx Measured Data Branch Navigation Chart

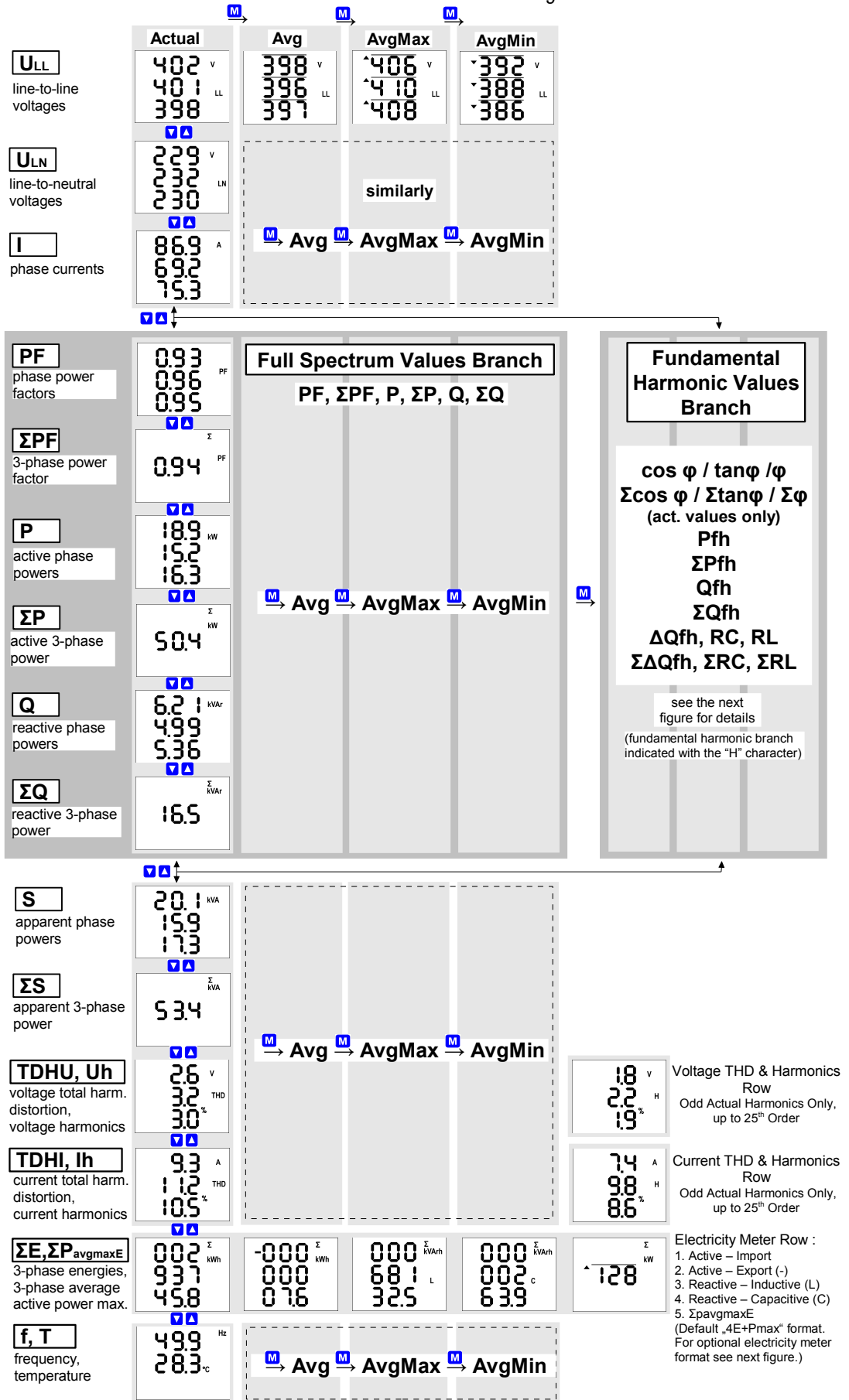

NOVAR 24xx Fundamental Harmonic Measured Values Branch

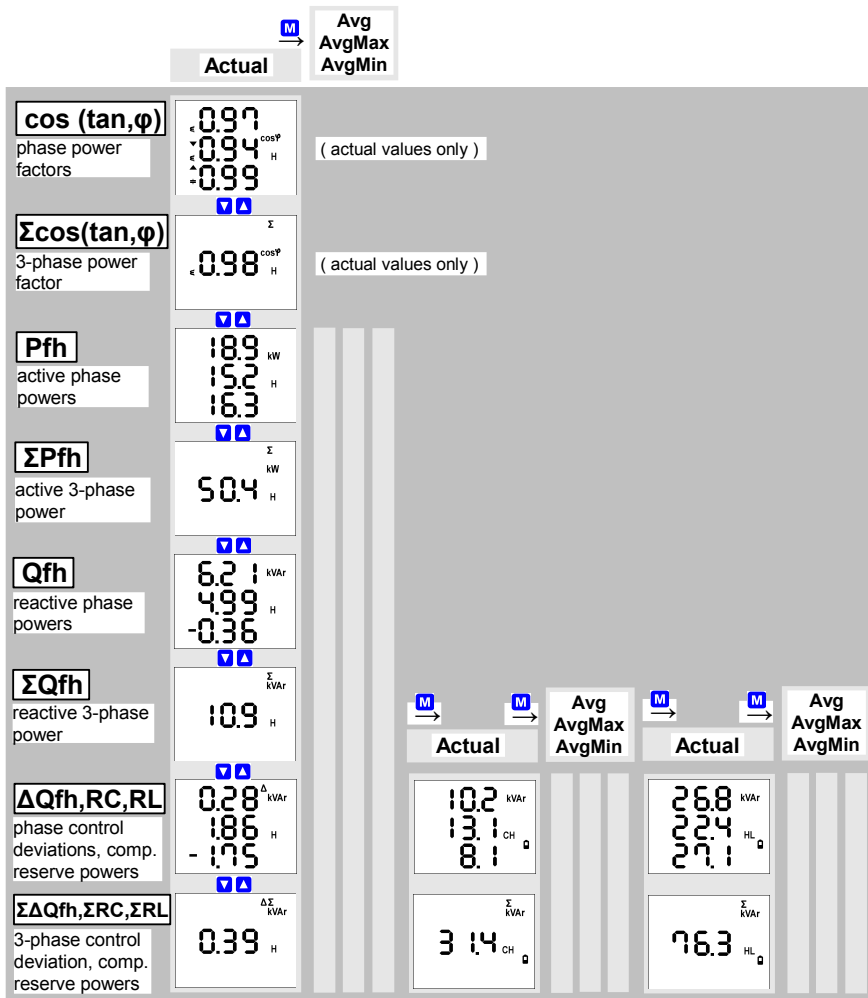

Optional "8E" Electricity Meter Display Format

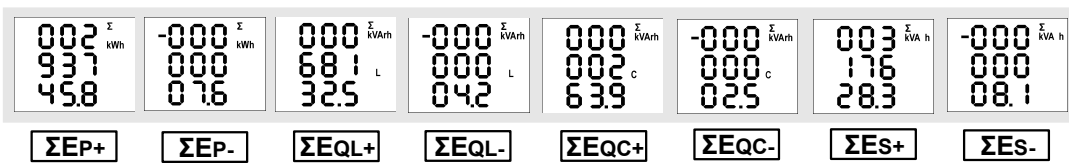



## 2. Installation

### 2.1 Physical

The instrument is built in a plastic box to be installed in a distribution board panel. The instrument's position must be fixed with locks.

Natural air circulation should be provided inside the distribution board cabinet, and in the instrument's neighbourhood, especially underneath the instrument, no other instrumentation that is source of heat should be installed.

### 2.2 Instrument Connection

#### 2.2.1 Power Supply

The instrument requires an AC or DC voltage power supply as specified in technical parameters. The supply inputs are galvanically separated from other circuits of the instrument.

It is necessary to connect an auxiliary supply voltage in the range as declared in technical specifications table to the terminals **AV1** ( No. 9, L ) and **AV2** ( No.10, N ). In case of DC supply voltage the polarity of connection is generally free, but for maximum electromagnetic compatibility the grounded pole should be connected to the terminal **AV2**.

The supply voltage must be connected via a disconnecting device ( switch - see installation diagram ). It must be situated directly at the instrument and must be easily accessible by the operator. The disconnecting device must be labelled as the disconnecting device of the equipment. A double circuit breaker at the nominal value of 1A may be used for the disconnecting device; however its function and position must be clearly marked (symbols „O" and „I" according to EN 61010 – 1). If one of the supply signals is neutral wire N (or PEN) usually a single breaker in the line branch is sufficient.

Since the instrument's inbuilt power supply is of pulse design, it draws a momentary peak current on powerup which is in order of magnitude of amperes. This fact needs to be kept in mind when selecting the primary protection devices.

Fig. 2.1: Typical star (3Y) connection, mains 3 x 230/400 V

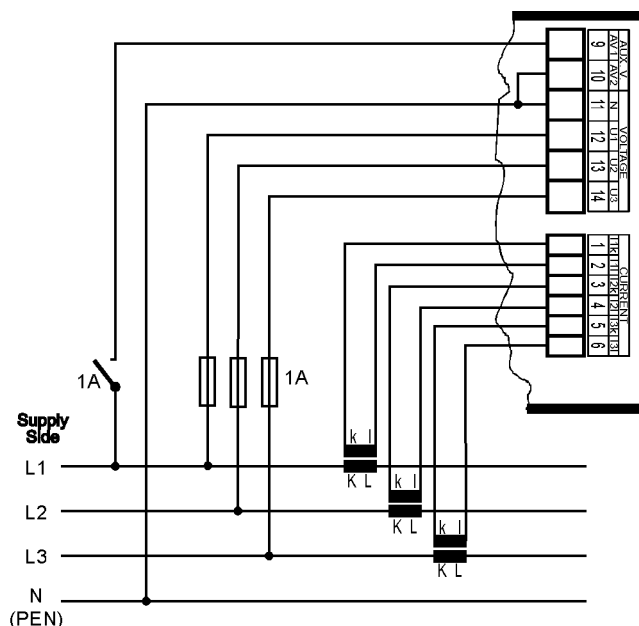

## 2.2.2 Measured Electrical Quantities

### 2.2.2.1 Measured Voltages

Measured voltages in wye ( star ), delta or Aron connection connect to terminals **VOLTAGE / N** (No. 11), **U1** (No. 12), **U2** (No. 13), and **U3** (No. 14). Phase rotating direction is free.

Types of connections are stated in the following table.

Tab. 2.1: Connection of the measured voltages – **VOLTAGE** group of terminals

Terminal VOLTAGE	Type of connection		
	wye-star (Y)	delta (D)	Aron (A)
U <sub>1</sub>	L1-phase voltage	L1-phase voltage	L1-phase voltage
U <sub>2</sub>	L2-phase voltage	L2-phase voltage	L2-phase voltage
U <sub>3</sub>	L3-phase voltage	L3-phase voltage	L3-phase voltage
U <sub>N</sub>	neutral wire voltage	-	-

It is advisable to protect the supply leads by 1A safety fuses.

The type of voltage and currents connection must be entered in *Installation* parameters : the code shows the amount of connected phases, **3Y** means three-phase connection in wye ( star ), **3D** in delta. **3A** means Aron connection. For setup **1Y** the instrument measures phase L1 only and 3-phase values are simulated.

In the case of indirect connection via the measuring voltage transformers, it is necessary to enter this matter ( connection **Mode** ) and the values of the VT ratios during the setup of the instrument.

### 2.2.2.2 Measured Currents

The outputs from the current transformers (CT) are connected to terminal pairs **CURRENT / I1k – I1l** (No. 1, 2), **I2k – I2l** (No. 3, 4) and **I3k – I3l** (No. 5, 6). CTs with the nominal output current of 5A or 1A can be used.

During mounting, it is necessary to observe the polarity of CTs – otherwise the values of the power factors, powers and electric energy will not be evaluated correctly.

For measuring and evaluation of three - phase power factor, three - phase powers and electric work in Aron connection, only currents I<sub>1</sub> and I<sub>3</sub> will be connected.

A particular connector is provided with a screw lock to prevent an accidental pullout and possible unwanted disconnection of the current circuit.

Examples of connections are mentioned at the appropriate chapter below.

It is necessary to enter the CT ratio values or current ranges during the setup of the instrument in *Installation* parameters (see below).

The maximum cross section of the conductors to the terminal panels is 2.5 mm<sup>2</sup>.

## 2.2.3 Relay Outputs

Instruments can have up to 18 relay outputs. For models with more than 9 outputs, the outputs are arranged in two output groups. The groups are isolated from each other. Each group has one relay common pole terminal **C1, C2** ( No.15 and 25 ) and up to nine individual relay output terminals **1.1** through **1.9** ( No.16 ÷ 24 ) for group No. 1 and **2.1** through **2.9** ( No.26 ÷ 34 ) for group No. 2.

Fig. 2.2: Output connection example, various types of capacitors

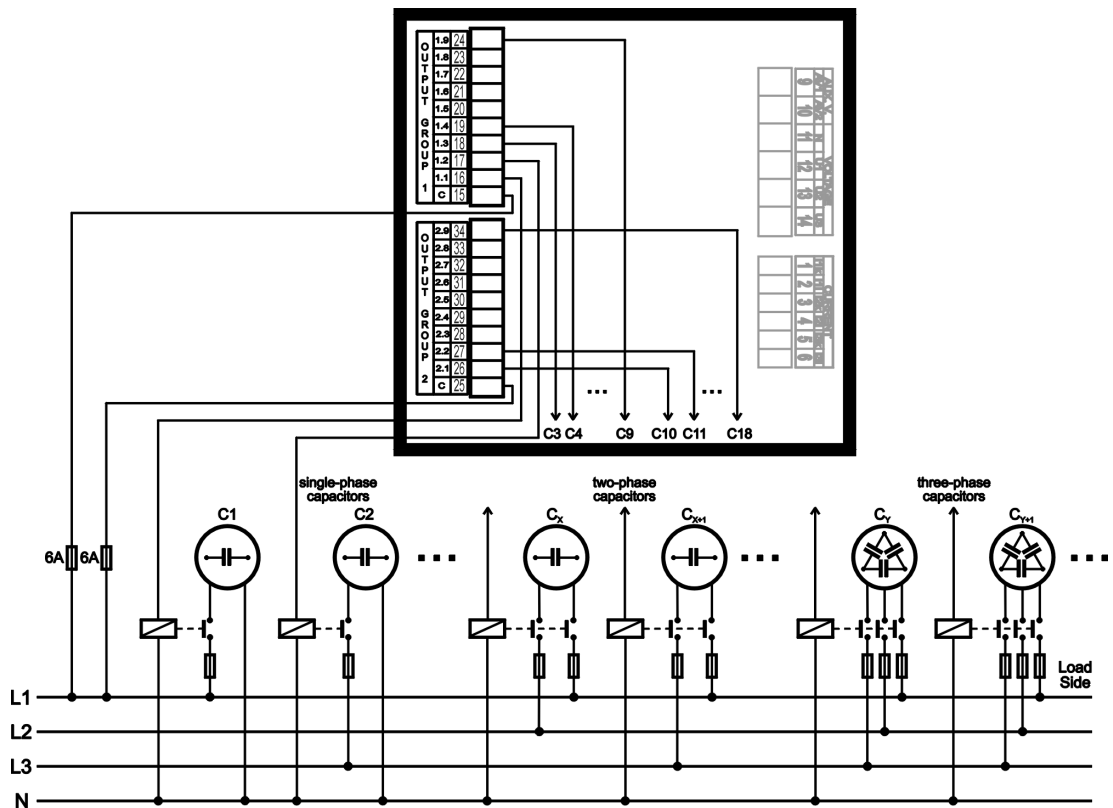

Any combination of compensation capacitors or chokes (three-phase, two-phase or single -phase) can be connected to the instrument outputs via appropriate contactors.

If not of all outputs used, you can use upper three relay outputs for alarm signalling or for heating/cooling control ( see example wirings further below).

## 2.2.4 Digital Input

The „D“-type models are equipped with the digital input. It can be used for the 2<sup>nd</sup> tariff control of power factor control process, for time synchronization or for electricity meter tariff control.



Use terminals No.23 and 24 for the digital input connection – see wiring examples in appropriate chapter further below. The input is galvanically isolated from other instrument circuitry.

To activate the output apply voltage of specified range to the terminals.

## 3. Commissioning

### 3.1 Setup

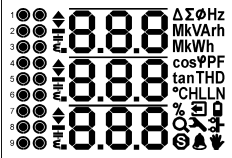
On connecting power supply, the instrument performs internal diagnostics, display test and then gradually shows screens with the instrument type and setting of basic parameters :

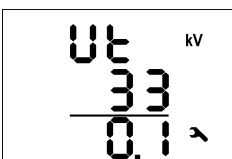
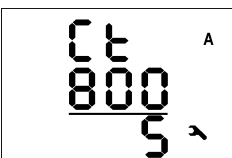
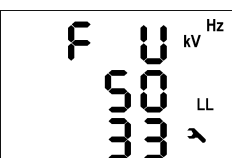
- |   |  |
|---|--|
|    | 1. Instrument diagnostic in progress   |
|    | 2. Display test  |
|   | 3. line 1 : <b>n 18</b> - instrument model (Novar 2418)<br>line 3 : <b>1.00</b> - firmware version number  |
|  | 4. when connection of voltage via voltage transformers set (otherwise the screen is skipped) :<br>line 1 : <b>U t</b> - voltage transformer ratio specification<br>line 2 : <b>33</b> - nominal primary voltage [kV]<br>line 3 : <b>0.1</b> - nominal secondary voltage [kV] |
|  | 5. line 1 : <b>C t</b> - current transformer ratio specification<br>line 2 : <b>800</b> - nominal primary current [A]<br>line 3 : <b>5</b> - nominal secondary current [A]   |
|  | 6. line 1 : <b>F U</b> - nominal frequency and voltage specification<br>line 2 : <b>50</b> - nominal frequency [Hz]<br>line 3 : <b>33</b> - nominal voltage [kV] ( line-to-line)   |

Then the instrument starts display actual measured values. Simultaneously, if the instrument has a communication line, it can be set and its measured values read via the communication link using a PC.

As, because of the first installation, the instrument knows neither output types nor reactive power sizes of individual outputs, it gets into the *standby* mode, which is signalled by flashing symbol .

If all of measuring voltages are present and all of measured currents reach at least minimum level, the instrument tries to start *automatic output recognition* ( AOR ) process that is indicated with flashing symbol  and the **AOR** message. As soon as it occurs, switch into instrument parameters with the

 key. When parameters are displayed, the AOR-proces is cancelled and the controller stays in the

standby mode until it returns back to measured quantities display – that occurs automatically after about 30 seconds if no key is pressed.

At this moment, before we let the AOR-process running it is necessary to set group of parameters - so called *Installation* group - that are essential for proper operation of the instrument :

- mode of connection ( direct measuring or via metering voltage transformers - p. 74 )
- type of connection ( star, delta, Aron – p. 72 )
- ratios of CT and VT(if used – p.74 )
- nominal voltage  $U_{NOM}$  and nominal frequency  $f_{NOM}$  ( p.75 )
- $P_{NOM}$  (not mandatory, but recommended – p.76)

### 3.1.1 Measured Electrical Quantities Installation Setup

For proper data evaluation it is necessary to set the *Installation Setting* group parameters, starting from parameter 71 up. They comprise :

- **CT- ratio** ( p. 71 ). Can be set in form either .../ 5A or .../ 1A.
- **Connection Type** ( p. 72 ) needs to be set according network configuration – wye ( or star,  $\mathbf{Y}$  ) delta (  $\mathbf{d}$  , if neutral voltage potential not connected ), or Aron (  $\mathbf{A}$  ). Usually, all of three phases are connected so choose  $\mathbf{3Y}$  ,  $\mathbf{3d}$  or  $\mathbf{3A}$  . For single-phase connection, set  $\mathbf{1Y}$  .
- **Connection Mode** ( parameter 74 ) determines if voltage signals are connected directly ( - - ) or via voltage transformers. In such case the **VT-ratio** must be set. The VT-ratio must be set in form *Nominal primary voltage / 0.1 [kV]* . If VTs with different secondary voltage are used, the nominal primary voltage must be recalculated to 100 V of secondary voltage - for example if a VT with ratio of 220 kV / 110 V is used value 200 / 0.1 kV must be set.
- Nominal frequency  $f_{NOM}$  ( p. 75 ) must be set in compliance with the measurement network nominal frequency to either 50 or 60 Hz.
- **Nominal Voltage  $U_{NOM}$**  ( p. 75 ) and **Nominal Power  $P_{NOM}$**  ( p. 76 ) : For the presentation of voltages and powers in percent of nominal value, voltage alarms operation and other functions it is necessary to enter also the nominal ( primary ) voltage of the measured mains  $U_{NOM}$  and nominal apparent three-phase power (input power) of the connected load  $P_{NOM}$  ( in units of kVA ). Although the correct setup of the  $U_{NOM}$  and  $P_{NOM}$  has no effect on measuring operation of the instrument, it is strongly recommended to set at least the  $U_{NOM}$  correctly.

Correct setting of the  $P_{NOM}$  is not critical, it influences percentage representation of powers and currents and statistical processing of measuring in the software only. If the  $P_{NOM}$  of measured network node is not defined, we recommend to set its value, for example, to the nominal power of source transformer or to the maximum supposed power estimated according current transformers ratio, etc.

The  $U_{NOM}$  is displayed either as line-to-neutral or line-to-line form depending on the connection mode setup : “direct” or “via VT”, respectively.

#### 3.1.1.1 Setup Example

Usually, it is only necessary to adjust the CT ratio. Next example shows how to do it :

Assuming that the ratio of used CTs is 750/1 A. First off all, it is necessary to switch display from measured data branch (the ULN screen on the example below) to *the parameter branch* with the 

button. The branch is indicated with the symbol . Parameter 01 appears – target power factor & control bandwidth.

Now scroll down with the key to parameter 71, that is the CT ratio -its default value is 5/5 A. Enter editing mode by pressing and holding the until the value gets flashing.

As soon as the value flashes, release the . Now you can change it. Increase primary value by pressing of the . If you keep it pressed two-speed autorepeat helps to reach target value quickly. Then use multiple pressing of and for fine setup.

To change the secondary value, simply press the . The button serves as toggle switch between 5 and 1.

*CT Ratio Change Procedure Example*

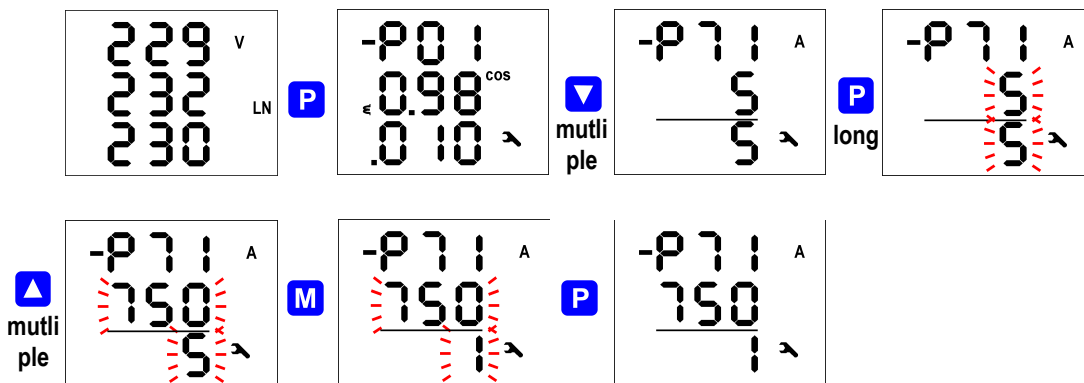

Target CT value is prepared now and we can leave the edit mode with (short) pressing the . The value is stored into the instrument memory and the flashing stops.

Now you can scroll to other parameters with and and edit them in a similar way or you can return to the measured data branch with the .

The summary of all instrument parameters is stated in the table below. Their description is stated in following chapters.

After all of the installation parameters set, it is time to set the power factor control (PFC) parameters.

### 3.1.2 PFC Setup

Another group of parameters serves for power factor control operation setup. The parameters can be divided into following subgroups :

- PFC control setup
- PFC output setup
- PFC alarm setup ( parameters 40 ÷ 56 )

#### 3.1.2.1 PFC Control Setup

The PFC control setup group comprises basic control parameters such like target power factor etc. They are numbered in range 01 ÷ 19.

But first at this phase, it is essential to set the parameter 11 - *the power factor control strategy* :

- **3 IP** ... set this strategy if both three-phase and individual single phase power factors need to be controlled
- **3 P** ... set this strategy if three-phase power factor control only is required
- **IP** ... set this strategy if all of single-phase power factors to be controlled individually without any relation to each other (3 separately running single-phase control processes, usable for single phase outputs only)

Other parameters can be modified later. Finally, the last step is PFC output setup.

### 3.1.2.2 PFC Output Setup

The PFC output setup is determined by parameters 20 ÷ 36.

For the first commissioning, check and - if required - modify *the discharge time for set 1* ( parameter 34 ). The time is displayed in format MM.SS ( minutes.seconds ). It is necessary especially at high voltage compensation systems where discharge time in range of minutes must be set.

Now you can finally set output types and sizes. The most comfortable way to do this is by using *Automatic Output Recognition (AOR)* process. At the first commissioning, the process is started automatically after return to measured quantities display - either manually with the key **M** or automatically after about 30 seconds without any key manipulation ( to force restart of the AOR-process later, scroll to parameter 20 and edit its value to **rUn** ).



*If load is low or disconnected at all, the default undercurrent ( **I** ) alarm ( No. 04, parameter 43 ) actuation forces the controller into the standby state. In such case the AOR process cannot be started. Therefore, it is necessary to switch this alarm actuation temporarily off ( and to return it back after the AOR-process passes ).*

### 3.1.2.3 AOR-Process

After being started, the AOR screen appears : the **AOR** message in the first line and the symbol **Q** flash.

First of all, all of control outputs (i.e. excluding the fixed ones and optional alarm/fan/heating ones ) are disconnected, step by step.

Then the instrument waits until discharge time of the outputs just disconnected expires - such not-discharged outputs are identified with flashing output symbol. That means that the instrument waits till output No. 1.1 is ready to use.

*AOR-Process Step 1.1 Recognition Example*

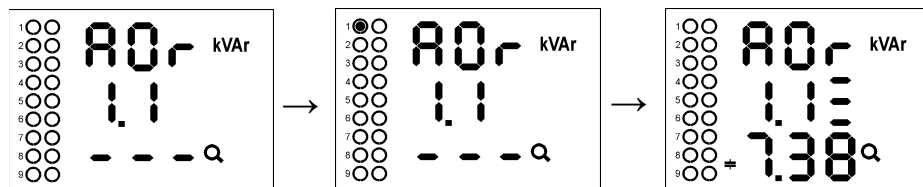

After all of the outputs discharged, the instrument starts to switch the outputs step by step. The number of a step is displayed in the second line and appropriate output is switched on for a short time. After the step is switched off, its type and size is displayed :

- three-phase reactive power of 7.38 kvar, capacitive, in the third line
- in the second line (behind the output number) type of the capacitor – three-phase type (C123) because of all of three bars displayed behind the step number

If a step power was detected as zero, either the output is not used (nothing connected to it) or the step power is too small to be recognized automatically.

After the process passes, new recognized output data are stored into the instrument's memory.

Then, in case that :

- at least one valid output ( capacitor or choke ) was found
- the instrument is not switched into the *manual* mode
- no alarm action is active
- voltage and current higher than measurable minimums at least in one of phases

the instrument starts to control power factor to preset value.



*If the undercurrent (  $I_K$  ) alarm ( No. 04, parameter 43 ) was disabled for the AOR-process to be able to pass without any load in the network do not forget to reenable it back !!!*

You can find detailed AOR process description in appropriate chapter below.

The instrument includes a row of other parameters – their description is stated in following chapters.



## 4. Detailed Description

### 4.1 Basic Functions

NOVAR 2xxx-line power factor controllers are fully automatic instruments that allow optimum control of reactive power compensation.

Control is provided in all four quadrants and its speed depends on both control deviation value and its polarization (overcompensation / undercompensation). Connecting and disconnecting power factor capacitors is carried out in such a way that achieving the optimum compensation condition is by a single control intervention at minimum number of sections connected. At the same time, the instrument chooses relay sections with regard to their even load and preferably connects those that have been disconnected for the longest time and the remanent charge of which is thus minimum.

Within the control process the instrument continually checks the relay compensation sections. If a section's outage or change in value is detected, the section is temporarily disabled from control under relevant setting. The section temporarily disabled is periodically tested and enabled for control again when possible.

Wide assortment of the instrument's alarms can be used both for indication and protection of the compensation elements. It is, for example, possible to preset the THD and the CHL threshold levels at which the controller disconnects all compensation sections thus preventing their damage. Besides that, the most adverse values are recorded into the instrument's memory for subsequent analysis.

Besides the power factor capacitors, it is possible to connect power factor chokes (power system decompensation). Any output can be set as fixed, the three highest outputs can also be used as alarm output or to connect the cooling or heating circuits.

The controllers can be equipped with different numbers of outputs up to 18.

### 4.2 Measured Data & Status Presentation

The instrument starts display actual measured values on power-up. The screen that was selected before the last powerdown is displayed.

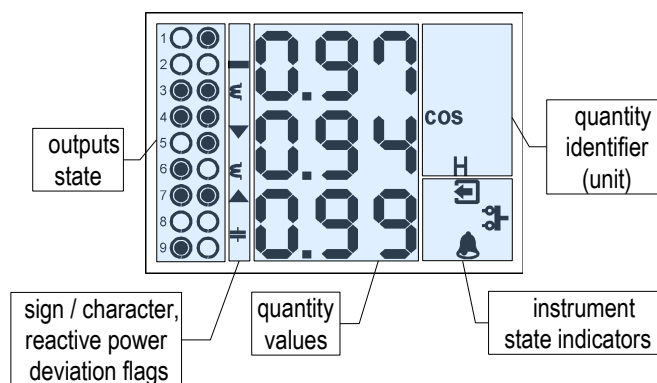

Fig. 4.1 :  
Phase Power Factor Actual Values  
Example



## 4.2.1 Measured Data Screen

The instrument screen comprises following fields :

- *outputs state* ... actual state of the outputs
- *displayed quantity values, sign & reactive power deviation flags* .... quantities' actual / avg / avgmax / avgmin values and reactive power deviation flags
- *quantity identifier* ... specifies the quantity displayed, usually with its unit shortcut
- *instrument state indicators* ... indicates the instrument current status



At the field you can observe all of essential network quantities (see the quantities overview below) associated with corresponding identifier. You can navigate through all of measured and evaluated values with ,  and  buttons as shown on *the NOVAR 24xx Measured Data Branch Navigation Chart* above.

If phase values displayed, individual L1 / L2 / L3 - phase value is shown in the line 1 / 2 / 3. If a three-phase value is displayed, it is shown in the line 2 and the  $\Sigma$  symbol appears.

The quantities' meaning and evaluation formulas can be found in the appropriate chapter further below.

Most of data are arranged in four columns :

- Actual .... actual values, refreshed each 3 measurement cycles (30/36 mains cycles)
- Avg ..... average values per appropriate averaging period (see below)
- AvgMax ... maximum of the avg-value reached since the last clearing
- AvgMin .... minimum of the avg-value reached since the last clearing





You can scroll inside a column down and up with the  and  keys and move horizontally from a column to the next right one cyclically with the  key.

Exception : Only actual values of harmonics and electrical energy are available. These values are arranged in different way – see further below.



*When a power factor decimal point flashes the offset control is activated. See parameter 13 description.*

Tab. 4.1 : Quantities Overview

row	quantity mark	quantity	quantity identifier	note
1	$U_{LL}$	line-to-line voltages	V LL	
2	$U_{LN}$	line-to-neutral voltages	V LN	
3	I	currents	A	
4	PF or $\cos\varphi / \tan\varphi / \varphi$	phase power factors (full spectrum) / phase fund. harmonic power factors	PF or $\cos / \tan / \varphi$	the fund. harmonic power factor format selectable to $\cos\varphi / \tan\varphi / \varphi$ with the parameter 79
5	$\Sigma PF$ or $\Sigma \cos\varphi / \Sigma \tan\varphi / \Sigma \varphi$	three-phase power factor (full spectrum) / three-phase fund. harmonic power factor	$\Sigma PF$ or $\Sigma \cos / \Sigma \tan / \Sigma \varphi$	
6	P or Pfh	phase active powers (full spectrum) / phase fund. harmonic active powers	W or W H	
7	$\Sigma P$ or $\Sigma Pfh$	three-phase active power (full spectrum) / three-phase fund. harmonic active power	$\Sigma W$ or $\Sigma W H$	
8	Q or Qfh	phase reactive powers (full spectrum) / phase fund. harmonic reactive powers	VAr or VAr H	
9	$\Sigma Q$ or $\Sigma Qfh$	three-phase reactive power (full spectrum) / three-phase fund. harm. reactive power	$\Sigma VAr$ or $\Sigma VAr H$	
10	$\Delta Qfh$ , RC, RL	phase fundamental harmonic control deviations , phase compensation reserves (capacitive and inductive)	$\Delta VAr H$ , VAr C H  , VAr L H 	skipped at the full spectrum branch
11	$\Sigma \Delta Qfh$ , $\Sigma RC$ , $\Sigma RL$	three-phase fundamental harmonic control deviation, three-phase comp. reserves (capacitive and inductive)	$\Sigma \Delta VAr H$ , $\Sigma VAr C H$  , $\Sigma VAr L H$ 	
12	S	phase apparent powers	VA	
13	$\Sigma S$	three-phase apparent power	$\Sigma VA$	
14	THDU, CHL, Uh	total harmonic distortion of voltage, capacitor harmonic load, voltage harmonics	V THD % V CHL % V H %	
15	THDI, Ih	total harmonic distortion of current, current harmonics	A THD % A H %	
16	$\Sigma E$ , $\Sigma P_{avgmaxE}$ or $\Sigma E$	three-phase energies (4 quadrants), three-phase max. active power demand / three-phase energies (8 „quadrants“)	$\Sigma Wh$ , VArh, $\Sigma W$ / $\Sigma Wh$ , VArh, VAh	depends on the parameter 78 setup
17	f, T	frequency, temperature	Hz, °C	

## 4.2.2 Average Values

Average values are processed according set averaging method and length of averaging window (individually for “U/I”-group and “P/Q/S”-group of quantities). Maximum and minimum values of them are registered into the instrument’s memory. The maximums are displayed in the “AvgMax” column and they are identified with the ▲ symbol in the front of the value. Analogically, the minimums in the “AvgMin” column are identified with the ▼ symbol.

Fig. 4.2 :  
Three-Phase Maximum of Average  
Active Power Example

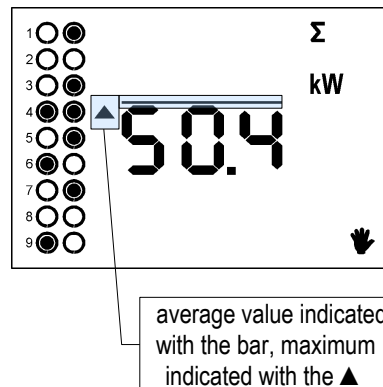

When the average values are displayed, deviation flags (see below) cannot be checked because of their symbols are used for the average value identification.



Neither maximum nor minimum of  $\cos\phi$  values are evaluated due to special character of the quantity. Similarly, these extreme values are not evaluated at harmonics.

You can clear the “AvgMax”/“AvgMin” values. All of the maximums/minimums of appropriate quantity group are cleared simultaneously. To do it, follow next :

- navigate on corresponding AvgMax or AvgMin value
- press the **M** key until the value starts flashing
- with the ▲ or ▼ key, choose the **CL** option
- then confirm by pressing the **M**



The appropriate group of quantities ( either U/I or P/Q/S ) average maxs/mins is affected by single clearing only ! Each group must be cleared individually.



If the instrument is locked, the clearing is not possible.

## 4.2.3 Full Spectrum Values $P/Q/PF$ & Fundamental Harmonic Values $P_{fh}/Q_{fh}/\cos\varphi$

As standard, active and reactive powers (and therefore power factors) are evaluated from full spectrum of harmonic components of both voltage and current.

Sometimes (for example for power factor compensation system checking), it is useful to know fundamental harmonic part of these quantities too. Such quantities are marked  $P_{fh}$ ,  $Q_{fh}$ ,  $\cos\varphi$ .

As you can see on the navigation chart you can navigate from *the full spectrum values branch* with the

**M** key further right into *the fundamental harmonic values branch* and vice versa. To distinguish actual displayed branch, the **H** symbol is displayed for the fundamental harmonic branch.



Actual values only of fundamental harmonic power factor – the  $\cos\varphi$  – are evaluated (no average values available).



The fundamental harmonic power factor can be expressed not only as  $\cos\varphi$ , but as  $\tan\varphi$  or  $\varphi$  too, depending on setting of parameter 09.

## 4.2.4 Fundamental Harmonic Power Factor Formats $\cos\varphi/\tan\varphi/\varphi$

The fundamental harmonic power factor can be expressed not only as  $\cos\varphi$ , but as  $\tan\varphi$  or  $\varphi$  too, depending on setting of parameter 09. At the following figures there are examples of three-phase fundamental power factor presentations :

Fig. 4.3 :  
Fundamental Harmonic Power Factor  
Formats

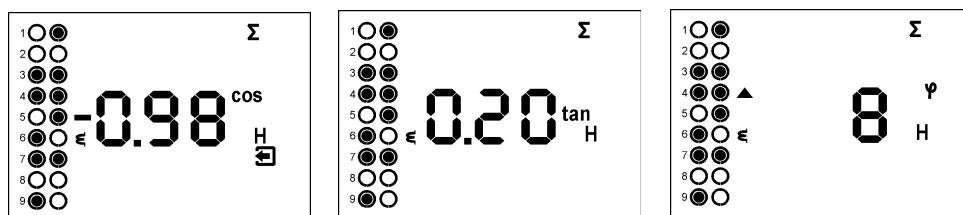

- the left figure :  $\Sigma\cos\varphi = 0.98$  inductive (choke symbol displayed). Furthermore, active three phase power is just negative, therefore the leading “minus”-sign ( and the symbol displayed )
- the middle figure :  $\Sigma\tan\varphi = 0.20$  inductive. Three phase power is just positive.
- the right figure :  $\Sigma\varphi = 8$  degrees inductive. Three phase power is just positive.

For outright specification of the quadrant, the power factor of the fundamental harmonic component is expressed according to the graph with two attributes :

- a sign ( + or - ), which indicates polarity of appropriate active power
- a character ( or ), which indicates the power factor character ( the polarity of reactive power relative to the active power )

Fig. 4.4 :  
Fundamental Harmonic  
Power Factor Sign &  
Character

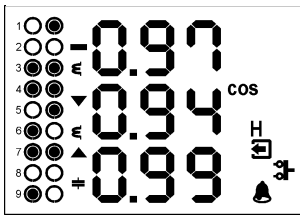

On the figure on the left, there is phase  $\cos \varphi$  values example :

- $\cos \varphi_1 = 0.97$  inductive. L1-phase active power is currently negative (because of leading "minus"-sign)
- $\cos \varphi_2 = 0.94$  inductive ( L2-phase active power currently positive )
- $\cos \varphi_3 = 0.99$  capacitive ( L3-phase active power currently positive )

The arrows indicate control deviations – see the next chapter.

## 4.2.5 Deviation Flags

When actual data displayed, the control deviation flags can appear in the front of the values. These flags show the magnitude of deviation of the instantaneous reactive power in the power system from tolerable reactive power range defined by the specified value of required power factor and control bandwidth.

The deviations are evaluated both individually for each phase by corresponding phase deviation ( considering the smallest corresponding phase reactive power component ) and for total three-phase outlet. Numeric value of this quantity, *the  $\Delta Q_{fh}$* , can be listed at appropriate row.

Either single-phase deviation flags or total three-phase deviation flag is displayed :

- if any of individual phase quantities' screen is displayed, *single-phase control deviation  $\Delta Q_{fh1}$ ,  $\Delta Q_{fh2}$ ,  $\Delta Q_{fh3}$  flags* are displayed in appropriate lines 1, 2, 3 (Fig. 4.4)
- if any of three-phase quantities is displayed (symbol  $\Sigma$  shown), *the three-phase control deviation  $\Sigma \Delta Q_{fh}$  flag* is displayed in the line 2 (Fig. 4.3)

If the deviation is smaller than a half of the reactive power value of the smallest output, the flag is suppressed (balanced state). If the deviation is greater than a half of, but smaller than the reactive power value of the smallest output, the corresponding flag flashes — if lagging (undercompensation, positive  $\Delta Q_{fh}$  value ), the  $\nabla$  -flag flashes; if leading (overcompensation, negative  $\Delta Q_{fh}$  value ), the  $\blacktriangle$  -flag flashes. If the deviation exceeds the value of the smallest output, the corresponding flag is shown permanently.

The control deviation flags are not displayed when :

- a control deviation is such low that it does not exceed the power factor control range ( = balanced state, see further below)
- a control deviation cannot be evaluated due to voltage or current too low or no step power set ( then, if the controller was in the control mode it goes to the standby mode -see below for details)
- average values ( Avg/AvgMax/AvgMin ) are displayed, because the  $\blacktriangle$  and  $\nabla$  symbols are used for the value identification
- parameters are displayed, with exception of the control time parameter (No. 65)

## 4.2.6 THDs, CHL and Harmonics

You can check actual values of both voltage and current THDs and harmonic components in appropriate rows (see *the Measured Data Navigation Chart* ).

When you scroll to one of this rows, THD values of all measured phases are displayed as default. Identifiers **THD - V - LN** or **THD - A** indicate phase voltage or current THD values, respectively.

In the voltage THD row ,you can furthermore check the CHL values, marked with appropriate identifiers.

All of these values are expressed in percent and their averages and *AvgMax /AvgMin* values are available too.

By listing further right with the **M** key, you can switch to harmonic components. The symbol **H** appears, indicating harmonic components (of voltage or current). Symbol **%** means that the values are expressed in percent of fundamental harmonic component. Order of harmonics just displayed flashes periodically in the display middle line – for example, string **H03** means 3<sup>rd</sup> harmonics.

By repetitive pressing of the **M** key you can check other harmonics. Although the instrument evaluates all of the harmonic components up to 40<sup>th</sup> order internally, only odd components to 25<sup>th</sup> order can be viewed of its display (full spectrum of the harmonics is available via communication interface only).

## 4.2.7 Electricity Meter

Electricity meter comprises three-phase energy data and maximum three-phase active power demand value. The values are situated in particular row.

Depending on the parameter 78 setup, two electricity meter display modes can be chosen :

- “4E+Pmax” mode (default)
- “8E” mode

### 4.2.7.1 “4E+Pmax” Display Mode

In this mode, first four windows contain three-phase energies of four-quadrants :

- $\Sigma EP+$  ... three-phase imported active energy, indicated with  $\Sigma$  - kWh (or MWh or kWh = GWh)
- $\Sigma EP-$  ... three-phase exported active energy, indicated with  $\Sigma$  - kWh and preceding – sign
- $\Sigma EQ_L$  ... three-phase inductive reactive energy, indicated with  $\Sigma$  - kVARh – L
- $\Sigma EQ_C$  ... three-phase inductive reactive energy, indicated with  $\Sigma$  - kVARh - C

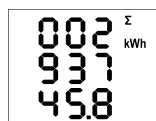

Each value occupies all of three display lines, 8 digits before the decimal point and one after it. For the example at left,  $\Sigma EP+$  = 293745.8 kWh.

The values are registered since the last clearing. To clear the energies, display any of them and then follow the same procedure as for max/min average values. All of the energies are cleared simultaneously and start to count from zero again.

In the 5<sup>th</sup> window there is

- $\Sigma P_{avgmaxE}$  ... maximum of three-phase average active power (power demand), indicated with  $\Sigma$  - kW - ▲ and bar over the value

The value contains maximum of three-phase average active power since the last clearing. Averaging method and averaging period for this value can be set regardless of the method of standard average values, described above. The quantity is marked with the “E” letter to distinguish from the standard maximum average quantities.

Similarly as the energies, the value can be cleared independently.



If the instrument is locked, clearing is not possible.



If the instrument is equipped with a communication interface, the values can be cleared remotely.

### 4.2.7.2 “8E” Display Mode

In this mode, reactive energies registered separately depending on actual three-phase active power ( $\Sigma P$ ) sign are displayed (“six-quadrant” mode; such format can be convenient for renewable sources monitoring, for example) :

- $\Sigma EP+$  ... three-phase imported active energy, indicated with  $\Sigma$  - **kWh** (or **MWh** or **kMWh** = **GWh**)
- $\Sigma EP-$  ... three-phase exported active energy, indicated with  $\Sigma$  - **kWh** and preceding — sign
- $\Sigma EQL+$  ... three-phase inductive reactive energy registered during the  $\Sigma EP$  value was positive (import); indicated with  $\Sigma$  - **kVArh** – **L**
- $\Sigma EQL-$  ... three-phase inductive reactive energy registered during the  $\Sigma EP$  value was negative (export); indicated with  $\Sigma$  - **kVArh** – **L** and preceding — sign
- $\Sigma EQC+$  ... three-phase capacitive reactive energy registered during the  $\Sigma EP$  value was positive; indicated with  $\Sigma$  - **kVArh** – **C**
- $\Sigma EQC-$  ... three-phase capacitive reactive energy registered during the  $\Sigma EP$  value was negative; indicated with  $\Sigma$  - **kVArh** – **C** and preceding — sign

Furthermore, energies in VAh are available too :



- $\Sigma Es+$  ... three-phase apparent energy registered during the  $\Sigma EP$  value was positive; indicated with  $\Sigma$  - **kVAh**
- $\Sigma Es-$  ... three-phase apparent energy registered during the  $\Sigma EP$  value was negative; indicated with  $\Sigma$  - **kVAh** and preceding — sign

The three-phase active power demand  $\Sigma P_{avgmaxE}$  is not displayed in this mode.

### 4.2.8 Outputs State

There are two columns of symbols indicating actual state of individual outputs on the left side of the screen. The first (left) column corresponds to the output group No. 1, the second column corresponds to the output group No. 2.

The symbols shows actual *output state* :

-  ... open output
-  ... closed output

In some cases (for example during *the AOR-process* or at output manipulation in *the manual mode* ), flashing output state symbol means that the output not yet discharged and, therefore, it waits until its discharge time expires before being closed.





## 4.2.9 State Indicators

### 4.2.9.1 Main Operating States

The controller works in one of two main states, that are indicated as follows :

- symbol  not displayed ... **control** state
- flashing symbol  displayed ... **manual** state

Moreover, the controller can enter following temporary substates :

- flashing symbol  ... **standby** state. The controller can enter this state from the control state only. It occurs either when the power factor control cannot be performed for some reason (voltage/current too low, no compensation steps available) or when operator switches display to parameters.
- flashing symbol  ... **AOR-process** or **CT-test** state. This states are usually initiated by an operator intervention. They can be started both from the control and manual state,

For detailed description the the controller states see appropriate chapter below.

### 4.2.9.2 Alarm

As soon as indication function of any of particular alarms (see alarm function description below) gets active, this symbol flashes. Simultaneously, if any of outputs is set to alarm indication, it is switched to the active state.

For detailed alarm cause detection, check alarm parameters (No. 40 ÷ 56).



*Exception : When any of the alarm parameters is displayed the symbol  does not indicate general alarm; the symbol is displayed (without flashing) when either indication or actuation function of the particular alarm listed is just active. Otherwise, the symbol is off. See the alarm function description further below.*

### 4.2.9.3 Active Power Export

This symbol is displayed whenever three-phase active power  $\Sigma P$  is negative. It indicates that active energy flows in opposite direction.

### 4.2.9.4 Digital Input State

If an instrument is equipped with a digital input, this symbol indicates its active state. If the input in passive state, the symbol is off.

### 4.2.9.5 Instrument Setup Indicator

This symbol indicates that instrument setup is displayed currently. It occurs when switching display to the instrument parameters with the  key.

During this, if the instrument was in *the control state*, it gets into *the standby state* simultaneously (with exception of the parameter 65).

## 4.3 Setup Parameters

For proper operation in particular conditions, the instrument must be set. The instrument setup is determined using parameters. The parameters can be divided into following groups :

- general meter group ( No. 00 and from No. 71 up)
- PFC control group ( No. 01 ÷ 19 )
- PFC output group ( No. 20 ÷ 39 )
- PFC alarm group ( No. 40 ÷ 56 )





*Exception : There are displayed **control time** and **standby cause** as parameters No. 65 and 66. In fact, these are not setup parameters – they bear additional information about the power factor control actual state. See detailed description further below.*

Overview of all the parameters is listed in the tables below.

### 4.3.1 Parameter Checking & Editing

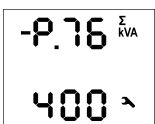
To check or edit the parameters, press the **P** key. As default, parameter group 01 is displayed and symbol  (wrench) indicates, that setup data are displayed now.



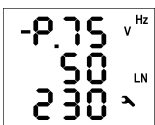

The parameters are arranged in groups, numbered from 00 up. The number of group is displayed in the first line in format - P.n n (with preceding dash). You can browse through the parameter groups with the  or  keys.



If one parameter only in the group, its value is in the bottom line as shown at the example (nominal power 400 kVA).

If two parameters in the group, usually the first of them is displayed in the 2<sup>nd</sup> line and the second in the 3<sup>rd</sup> line ( nominal frequency 50 Hz and nominal voltage 230 V).

To edit a particular parameter, scroll to its group. Then press and hold the **P** until the value gets flashing. Now release the key and set target value with the  or , or the **M** key for some of parameters. You can use autorepeat function by keeping one of the arrow keys pressed too. Finally, press the **P** and the value is stored into the memory.

If more parameters in the group, the first one is chosen when entering editing mode for the first time. If you want to modify the second parameter only, simply cancel editing of the first parameter without any change and reenter the editing again – now the second parameter is chosen.

To return back to measured values display, simply press the **M** key. Such return can occur automatically too when no manipulation with the buttons for about 30 seconds (with exception of the parameter 65, that has about 5 minutes autoreturn timeout ).

#### 4.3.1.1 Side Branch Parameters

The parameter groups are organized by ordinal number in the main branch – see figure below. *The main branch* is identified with a dash in the 1<sup>st</sup> line, preceding the parameter group number – for example - P25 .

Some of the parameter groups (No. 25÷28, alarm parameter groups No. 40÷56, etc.) are located on side branches for easier navigation. You can switch to a side branch with certain parameters by pressing the **P** key and switch back to the main branch in the same way. Unlike the main branch, when *the side branch* is selected the dash is displayed in the 2<sup>nd</sup> line.

For example: in the main branch, while showing parameter group 25 (section powers), you will see :

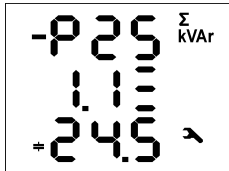

**- P 25** parameter group number with the preceding dash indicating the main branch

**1 . 1** - number of the 1<sup>st</sup> output section

**24 . 5** - section 1.1 power : three phase capacitor of 24.5 kvars

Pressing the **P** key you switch to the side branch and the screen changes as follows :

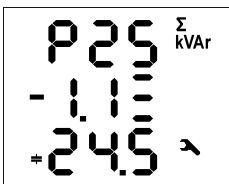

**P 25** parameter group number without the dash

**- 1 . 1** - number of the output with the preceding dash indicating the side branch

Now you can move up and down in the side branch with with the **▲** or **▼** keys through all sections' values.

Pressing the **P** again returns display to the main branch (the dash returns to the 1<sup>st</sup> line).

Figure 4.5: Parameter Display – Structure

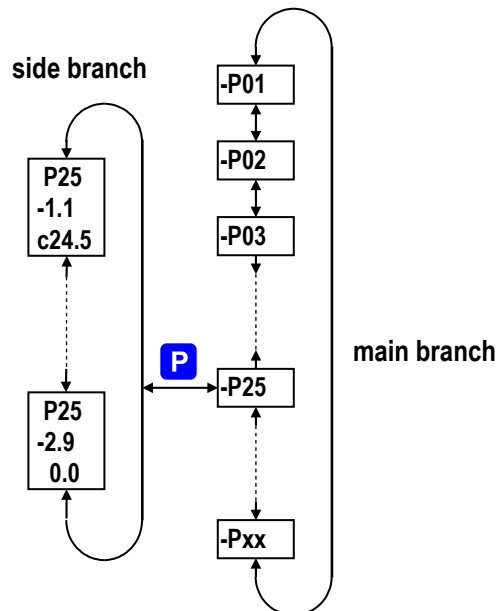

## 4.3.2 General Meter Parameters

Tab. 4.2 : General Meter Setup Parameters

#	parameter group	range	default	comment
00	lock	LOC / OPN	OPN	see Instrument Setup Locking / Unlocking
71	“X/5A” models : CT – ratio line 2 : nominal primary current line 3 : nominal secondary current “S” and “P” models : line 2 : nominal primary current range (fixed) line 3 : multiplier	primary : 1A ÷ 10 kA secondary : 5A / 1A	5 / 5 A	secondary current selection with the <b>M</b> key
72	connection type	3Y / 3D / 3A	3Y	
74	connection mode: direct (- - -) or VT-ratio: line 2 : primary U [ kV ] line 3 : secondary U (0.1 kV fixed)	primary: 0.1kV÷1MV	direct (- - -)	
75	f <sub>NOM</sub> , U <sub>NOM</sub> line 2 : f <sub>NOM</sub> [ Hz ] line 3 : U <sub>NOM</sub> [ V / kV ]	50 / 60 Hz 50 V ÷ 1MV	50 230	U <sub>NOM</sub> specification depending on connection mode : - direct : line-to-neutral - via VT : line-to-line
76	ΣP <sub>NOM</sub> [ kVA / MVA ]	1 kVA ÷ 999 MVA	-	
77	averaging period line 2 : for U/I group line 3 : for P/Q/S group	0.01 ÷ 60 (1 sec÷ 60 mins)	1 min 15 min	floating window type averaging method applied as default; thermal method indicated with symbol ▲
78	avg period for ΣP <sub>avgmaxE</sub> , El. meter mode line 2 : averaging period for ΣP <sub>avgmaxE</sub> , line 3 : Electricity meter display mode	0.01 ÷ 60 (1 sec÷ 60 mins) “4E+Pmax” / “8E”	15 min “4E+ Pmax”	floating window type averaging method applied
79	fund. harmonic PF display mode	cos / tan / fi	cos	
80	backlight	AUT / ON	ON	AUT-mode : the backlight is switched off automatically after approx. 5 minutes if no key is pressed to decrease power dissipation.
81	CT-test trigger point	--- / run	---	the CT-test can be launched here by setting value "run"
85	communication : row 2 : address row 3 : rate [ kBd ]	1 ÷ 255 4.8 ÷ 115	1 9.6	
86	communication protocol	P0 / P1n / P1E / P10	P0	P0 = KMB; P1 = Modbus RTU

### 4.3.2.1 Instrument Lock – Parameter No. 00

When shipped, parameter editing is unlocked, that means :

- all of the parameters can be edited
- standard average maximums / minimums, electricity meter energies ΣA and electricity meter maximum power demand ΣP<sub>avgmaxE</sub> can be cleared

After being put in operation, such operations can be locked (=disabled) to protect the instrument against unauthorized changes. Then operator can only check measured values and parameters, but cannot change anything, excluding special parameter No. 00, that serves as the instrument lock. It has one of two values :

**L O C** ..... instrument is locked

**O P n** ..... instrument is unlocked (open)

If the instrument is locked, you can unlock it using the following procedure, which is similar to editing of other parameters:

1. Press the **P** key and scroll to parameter group 00 with arrow keys – value **L O C** is displayed.
2. Press the **P** and hold it down until the value is replaced with flashing number between **000** and **999**. As an example, you can imagine flashing **345** is displayed.
3. Press the following sequence: **▼**, **▲**, **▲**, **▼**. The value changes gradually to **344**, **345**, **346**, **345**, so the same value is shown at the end as at the beginning.
4. Press the **P**. The flashing number is replaced with **0 P n**, indicating unlocked state.

The digit shown while entering the unlocking keypress sequence is random and it is not important for correct unlocking (it is there only to confuse). Only the sequence of keys pressed is important and must be followed exactly.

The instrument can be locked in a way analogous to unlocking but it is necessary to press any keypress sequence that is different from the unlocking sequence noted above.

### 4.3.2.2 Backlight Parameter, No. 80

LCD display backlight can be set as permanently on (**0 n**) or to auto-off mode (**A U E**), in which it is switched off automatically during approx. 5 minutes if no button is pressed to decrease the instrument power dissipation.

### 4.3.2.3 Other Parameters

Other parameters functions are explained :

- installation setting parameters No. 71 ÷ 76 in the chapter *Measured Electrical Quantities Installation Setup* above ( *the Commissioning* part )
- average values processing setting parameters No. 77 in the chapter *Average Values Evaluation* below
- average period for  $\Sigma P_{avgmaxE}$  & electricity meter display mode parameters No. 78 in the chapters *Embedded Electricity Meter Processing* further below and *Electricity Meter* above
- fundamental harmonic PF display mode in the chapter *Fundamental Harmonic Power Factor Formats  $\cos\phi/\tan\phi/\phi$*  above
- CT-test trigger point, parameter No. 81 : This not real setup parameter - it is auxiliary parameter whereby it is possible to start the CT-test. Detailed description of the CT-test function can be found in appropriate chapter below
- communication parameters No. 85 ÷ 86 in the chapter *Computer Controlled Operation* below

### 4.3.3 PFC Control Parameters

Tab. 4.3 : PFC Control Setup Parameters

#	parameter group	range	default	comment
01	target PF & bandwidth, tariff 1 line 2 : target PF (cos/tan/φ) line 3 : control bandwidth	- 0.80 ÷ 0.80 (cos) 0.000 ÷ 0.040 (cos)	(cos) 0.98 0.010	Other available formats : „tan“, „φ“. Toggled with the <b>M</b> key.
02	control time UC/OC, tariff 1 line 2 : c. time at undercompensation (UC) line 3 : c. time at overcompensation (OC)	5 sec ÷ 20 min 5 sec ÷ 20 min	3 min 30 sec	No „L“: control time reduction by squared proportion “L“: linear c. time reduction
03	offset power, tariff 1	any	0	Value corresponds to $U_{NOM}$ specified; p Displayed when <i>offset control</i> set only.
05	tariff 2 control	OFF / dig. input (InP) / power (P)	OFF	
06	target PF & bandwidth, tariff 2 line 2 : target PF (cos/tan/φ) line 3 : control bandwidth	- 0.80 ÷ 0.80 (cos) 0.000 ÷ 0.040 (cos)	(cos) 0.98 0.010	Other available formats : „tan“, „φ“. Toggled with the <b>M</b> key.
07	control time UC/OC, tariff 2 line 2 : c. time at undercompensation (UC) line 3 : c. time at overcompensation (OC)	5 sec ÷ 20 min 5 sec ÷ 20 min	3 min 30 sec	No „L“: control time reduction by squared proportion “L“: linear c. time reduction
08	offset power, tariff 2	any	0	Value corresponds to $U_{NOM}$ specified; p Displayed when <i>offset control</i> set only.
10	tariff 2 control power	0 ÷ 120 % $P_{NOM}$	0	Displayed when <i>tariff 2 control</i> set to <i>power</i> only.
11	control strategy	3p+1p (31P) / 3p (3P) / 3*1p (1P)	3p+1p (31P)	
12	choke control & choke control limit PF line 2 : choke control  line 3 : choke control limit power factor	OFF / mixed (M) / non-mixed (nM) - 0.80 ÷ 0.80 (cos)	OFF  1.0	Choke control limit power factor displayed when <i>choke control</i> set to <i>mixed</i> only.
13	offset control	OFF / On	OFF	

#### 4.3.3.1 Target Power Factor for Tariff 1/2, Parameter No. 01/06

The value of target power factor for tariff 1/tariff 2 is displayed in the line 2 of the parameter group 01/06. Negative value means lagging power factor, the positive one leading power factor.

It can be specified in one of three formats :

- **cos φ** ...cosinus of the voltage and current phasors angle; range -0,80 ÷ 0.80
- **tan φ** ...tangens of the voltage and current phasors angle; range -0,75 ÷ 0.75
- **φ** ...voltage and current phasors angle in degrees; range -35° ÷ +35°

To toggle between the formats, use the **M** key while the parameter editing.



When a power factor decimal point flashes the offset control is activated. See parameter 13.

### 4.3.3.2 Control Bandwidth on High Loads for Tariff 1/2, No. 01/06

The parameter is displayed in the line 3. Using it you can specify the control bandwidth on high loads (see Figure 4.6). The value entered specifies the range of reactive power in the C zone which constitutes condition considered as compensated, making the controller stop control interventions.

On low loads (zone A) and on medium loads (zone B), the control bandwidth is constant and corresponds to the  $O_{MIN}$  value ( reactive power of the minimum output ) – the band follows the power factor slope specified at width  $\pm(O_{MIN})/2$ . On high loads (zone C) the bandwidth increases so its limits correspond to adjustable deviation from the target power factor. For the cosine target power factor format , the standard bandwidth value in this zone is 0.010 or  $\pm 0.005$  – this condition is shown in the figure. If thus, for example, the target power factor is specified as 0.98, reactive power corresponding to power factor from 0.975 to 0.985 will be considered compensated condition in zone C.

Fig. 4.6 : Standard Control Bandwidth

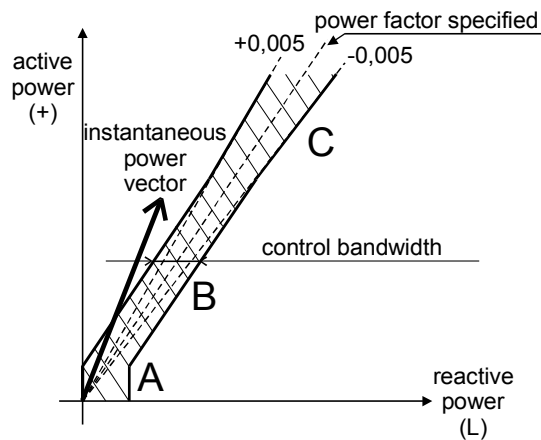

The control bandwidth format is the same as the target power factor. It can be set in range  $0.000 \div 0.040$  if the target power factor format is *cosinus*; if the format is *tangens* or *angle* , the control bandwidth range is  $0.000 \div 0.030$  or  $0 \div 15^\circ$  , respectively.

Control bandwidth increase may especially be useful in systems with large control range – avoiding uselessly precise control on high loads reduces the number of control interventions which results in longer contactor service life. If the parameter values is decreased to 0, the control bandwidth corresponds to value  $O_{MIN}$  (constant, not widening).

Note: On low loads, the control bandwidth is “bent” (zone A) to prevent undesired overcompensation (the illustration is a simplification).

### 4.3.3.3 Control Time for Tariff 1/2, No. 02/07

Power factor control passes discontinuously as a sequence of *control interventions*. The period between two consecutive control interventions is called *control time*.

The values for tariff 1 and tariff 2 can be specified in the range from 5 seconds to 20 minutes. It can be set different for undercompensation (marked as **UC**, in line 2) and overcompensation (**OC**, line 3) cases.

The value specified determines the frequency of control interventions under the following conditions:

- instantaneous power factor is either more inductive than the value required – undercompensated – or more capacitive – overcompensated
- the difference between reactive power instantaneous value in the power system and optimum value, which corresponds to the target power factor setting (= control deviation,  $\Delta Q_{fh}$  ), is just equal to the smallest output reactive power (  $O_{MIN}$  )

If the parameter value is set to say 3 minutes and the above mentioned conditions are met in the power system, the controller calculates optimum compensation and carries out control intervention every 3 minutes.

The time mentioned gets shorter in proportion to the instantaneous control deviation. If control time without additional character "L" is set, it gets shorter as square of control deviation over the smallest output reactive power ( $O_{MIN}$ ). If the control time with additional character "L" is specified, it gets shorter in proportion to this ratio ("L" = Linear, causes slower response to large deviations). Rising control deviation can decrease this value to the minimum control time of 5 seconds.

On the contrary, if the  $\Delta Q_{fh}$  control deviation is smaller than the smallest output reactive power ( $O_{MIN}$ ), control time gets twice as long. If the control deviation falls further under half of the smallest capacitive section current value ( $O_{MIN}$ ), no control interventions take place.

The control time countdown can be checked in the parameter 65.

#### 4.3.3.4 Offset Power for Tariff 1/2, No. 03/08

These parameters are meaningful when *offset control* (parameter 13, see below) is activated only. Unless this control mode is active, they do not appear.

The parameters specify *nominal value of the offset (three-phase) reactive power* for tariff 1, respectively for tariff 2. In the parameter you can specify not only the 3-phase reactive power value but the "offset power type" as well, in exactly the same way as compensation section powers (see parameter 25).

For example, if an offset control is required due to a front-end capacitor, you must specify capacitive offset power value. The controller will then intentionally undercompensate at its connection node just by the size of the specified offset power value.

Like the section powers, their values correspond to nominal three-phase power (i.e. at voltage corresponding to the preset compensation system nominal voltage  $U_{NOM}$ ). The actual value of the offset power is, as well as for capacitor and choke powers, dependent on the actual network voltage.

#### 4.3.3.5 Tariff 2 Control, No. 05

The controllers feature two sets of the above described control parameters. Each of the sets – marked as **1** and **2** - comprise following parameters :

- target power factor
- control bandwidth
- control times (*UC* and *OC*)
- offset power

The *tariff 2 control* parameter decides if the control process uses the first set of basic control parameters only or if, under certain circumstances, the second set of parameters for tariff 2 is used as well. The parameter can be set to :

- **0 F F** ... the controller uses tariff1 parameters set only, the tariff 2 set parameters are irrelevant
- **1 n P** ... (=input) actual tariff set is controlled by external signal. If the controller's digital input *is not activated* the *tariff1* set is used; if the controller's digital input *is activated* the *tariff2* set is used. This option is relevant only for controllers equipped with digital input.



- **P** ... (=power) actual tariff set is controlled by actual three-phase fundamental harmonic active power  $\Sigma P_{fh}$ . For details see *the tariff 2 control power* parameter (No. 10) description further below.

By default, *the tariff 2 control* parameter is off. The tariff 2 set of parameters is not significant in such an event, so the parameters are not shown.

If the tariff 2 control parameter is not off, you can check which tariff set of parameters is currently active in the 2<sup>nd</sup> line of the parameter screen : for example, message **t = 2** indicates that the tariff 2 is currently active.

### 4.3.3.6 Tariff 2 Control Power, No. 10

If *the tariff 2 control* parameter (No. 05) is set to **Power**, the 2<sup>nd</sup> set of the parameters listed above apply as soon as actual three-phase fundamental harmonic active power  $\Sigma P_{fh}$  drops below the preset level of the tariff 2 control power parameter. This limit value is set in percent of preset nominal power  $P_{NOM}$ .

If the tariff 2 control power parameter is entered with both of the symbols ▼ and ▲ interprets it as “**unsigned**” limit value of power. In such case the tariff 2 applies as soon as *absolute value* of the  $\Sigma P_{fh}$  power drops below preset level “T2CP”, i.e. inside the middle zone positioned symmetrically to both sides of zero power axis - see the lower tariff zone bar on the following figure.

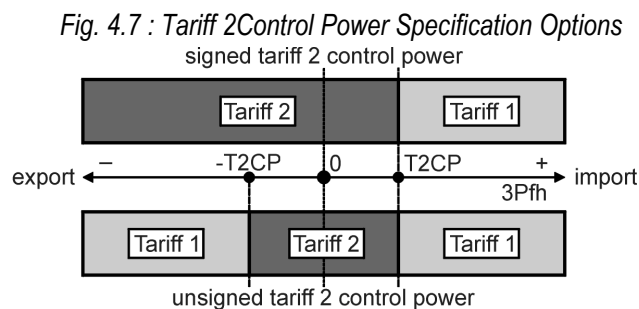

On the contrary, if *the tariff 2 control* parameter is entered with the symbol ▼ only the controller takes it as “**signed**” limit value of power. In such case the tariff 2 parameters applies as soon as positive  $\Sigma P_{fh}$  power drops below the preset level “T2CP” and keeps applied down to zero level and farther to all negative halfplane - see the upper tariff zone bar.

### 4.3.3.7 Control Strategy, No. 11

Power factor control is carried out by network operator requirements, mostly according local electric energy distributor billing scheme. Usually, only three-phase power factor is essential; but in some applications individual phase power factors must be controlled.

Accordingly, the power factor *control strategy* parameter must be set to one of following options :

- **3P** ... three-phase power factor control only is controlled (regardless single-phase power factor values)
- **3IP** ... (=3p+1p) three-phase power factor and individual single-phase power factors are controlled ( default setting )

- **1P** ... (=3\*1p) all of single-phase power factors are controlled individually without any relation to each other (usable for single phase outputs only)

If the **3p** strategy is set the total three-phase value of control deviation  $\Sigma\Delta Q_{fh}$  is determinative for power factor control process - both for the control time management and for control intervention evaluation.

At other settings, individual single phase control deviations control corresponding phase control times are processed.

If the **3p+1p** strategy is set, new control intervention occurs as soon as any of the phase control times expires. The common control intervention is evaluated to achieve optimal power factor in all of phases.

The **3\*1p** strategy is designed for independent single-phase power factor control. Three phase control times are evaluated simultaneously and when expired, separate corresponding phase control intervention is evaluated and executed. This strategy can be used when single-phase type compensation sections ( outputs) only are connected.

For details about the control times see „parameter“ 65.

### 4.3.3.8 Choke Control & Choke Control Limit Power Factor, No. 12

The instrument allows connecting chokes for power system decompensation. The decompensation system can be built as combined, in which case both chokes and capacitors are connected to the controller, or only chokes are connected. The control deviation evaluation and the control time countdown is derived from power of the smallest capacitor or of the smallest choke, whichever is less.

Any single-phase, two-phase and three-phase decompensation chokes can to be connected to any of outputs. But in case of combined decompensation systems, it is recommended to connect capacitors to the outputs 1.1÷1.4 in order *the CT-test* (see further below) can be optionally used.

By default, the choke control (in the line 2) is set as **OFF** in a shipped controller or after its initialization. With this setting the controller does not use chokes (or, generally, sections with inductive character ) that are available - such sections are permanently disconnected. Furthermore, neither available chokes in the automatic output recognition (AOR) process are detected.

In order the AOR process to determine values of the chokes connected and the controller to use the chokes for power factor control, *the choke control* parameter must be activated first : either **1** (=M=mixed) or **n1** (=nM=non-mixed) choke control mode must be set.

#### 4.3.3.8.1 Mixed Choke Control

Usually, one or few chokes only are installed in combined compensation systems. To reach sufficient precision of power factor control, a suitable set of capacitors are added to the choke(s) and controller freely combines both the chokes and the capacitors as needed to reach preset target power factor. We will call this mode as *mixed* mode.

If the mixed mode set, note that *the choke control limit power factor* parameter setting displayed in the line 3 affects the control operation too ( see below ).

If the mixed mode set, a choke is connected under the following circumstances:

- controller has disconnected all capacitive sections
- power factor is still more capacitive (leading) than that required and also more capacitive than the choke control limit power factor value specified ( exception: while offset control activation, this limit is neglected )

- this condition has lasted for five times longer than the overcompensation control time
- a choke is available at least at one output and it has such a value that after its connection it will be possible to control the power factor to desired value using a combination of capacitive sections, that is large undercompensation will not occur after its connection

If a number of chokes are available to the controller, the most suitable one, depending on their values, is connected, and another one is connected if the above described situation has lasted for another five times longer than overcompensation control time specified.

If a combination of chokes are connected and undercompensation occurs, such a number of chokes are disconnected after a normal undercompensation control time has elapsed, which prevent overcompensation.

#### 4.3.3.8.2 Choke Control Limit Power Factor (for Mixed Choke Control)

In mixed choke control mode, this parameter specifies power factor value at which the controller starts using, besides capacitive sections, inductive compensation sections for compensation as well – chokes (if available).

If the power factor measured is more inductive (current more lagging) than the value specified in this parameter, the controller uses only capacitive sections (capacitors) to control compensation.

If the power factor in the power system changes so that it is more capacitive (current more leading) than the choke control limit value, the controller starts using combination of capacitive and inductive compensation sections for compensation.



*Exception: This rule does not apply when offset control (see below) is activated ! In this case, the value of measured power factor is not decisive and the controller uses both capacitive and inductive sections, regardless of its value. This is true even if the offset power value is set to zero.*

#### 4.3.3.8.3 Non-Mixed Choke Control

There exist some applications (such as renewable resources power plants) where continuous power factor control in some range, usually symmetric to both sides from neutral value of 1, is required. In such cases the same or similar sets of both capacitors and chokes are installed.

The mixed choke compensation mode is often unsuitable for such installations. Therefore, so called *non-mixed mode* is implemented, that differs from the mixed one in following :

- control period corresponds to the overcompensation control time (i.e. not to the five times time at mixed control mode )
- during one control step, the controller switches combination of chokes to reach optimal power factor
- the controller never combines capacitors with chokes (first, it switches all of capacitors off, then switches chokes on and vice versa)

The choke control limit power factor parameter setting is irrelevant for this control mode, therefore it is not displayed.

#### 4.3.3.9 Offset Control, No. 13

In some cases it may be necessary to control "shifted" by a certain value of reactive power. A typical example is an installation of a power transformer compensating capacitor permanently connected to the transformer before the controller CT, or an installation of long power cable with not-negligible parasitic capacity. In such cases, so called *offset control* can be used.

As default, the parameter is **off**. In this setting, the offset control is disabled and the controller maintains the preset target power factor value.

If you set it to **on**, the offset control is activated with following consequences :

- *offset power for tariff 1* (No. 03 and , optionally, No. 08 for *tariff2* too) parameters appear and can be set in the PFC control setup group of parameters
- after the power factor control deviation (i.e. reactive power difference to achieve target power factor) is evaluated, the controller adds to it appropriate preset offset power value. Therefore, it controls to this “shifted” reactive power.
- if the offset power set to nonzero value flashing decimal point of both measured power factor values and target power factor (parameter 01/06) indicates that the offset control is active

*Example:*

A compensation capacitor with a nominal value of 5 kvars is permanently connected to a power transformer, which is before the controller CT. It is required to control the target power factor of 1.00, which is to be registered by an electricity meter, measuring whole transformer load. Then the controller must then set as follows:

- set target power factor to 1.00
- turn the offset control on
- set the offset power to 5 kvars (capacitive)

When, for example, an active load of 15 kW occurs, then balanced state will be reached at power factor of approximately 0.95 (measured by the controller). This value corresponds to the ratio of 5kvar / 15 kW. In other words, the controller will intentionally undercompensate by 5 kvar at the connected network point in order the target power factor of 1.00 to be reached in the electricity meter connection point, where the permanent capacitor comes to the effect.



*When the offset control is activated, the choke control limit power factor parameter value gets irrelevant.*

## 4.3.4 PFC Output Parameters

Tab. 4.4 : PFC Output Setup – Overview of Parameters

#	parameter group	range	default	comment
20	automatic output recognizer (AOR) starting	OFF / auto (A) / run	auto	
21	manual filler; 3 subparameters : 1. min. output type & nom. power ( $O_{MIN}$ ) 2. output ratio 3. count of outputs	any 11111 ÷ 12488 0 ÷ 18	C123 1 kvar 11111 0	
25	output type & nominal power, No.1.1 ÷ 2.9 in subparameters	any	0	Value corresponds to $U_{NOM}$ specified.
26	output control state No.1.1 ÷ 2.9 in subparameters	control / fixed-on / fixed-off / fan / heating / alarm-on / alarm-off	control	Fan, heating and alarm options available at three upper outputs only
27	output switching operations count No.1.1 ÷ 2.9 in subparameters	-	-	Not a presetable parameter. Can be cleared only.
28	output switch-on time [hours] No.1.1 ÷ 2.9 in subparameters	-	-	Not a presetable parameter. Can be cleared only.
29	the ultimate output fan/heater temperature thresholds line 2 : "on" temperature threshold [°C] line 3 : "off" temperature threshold [°C]	fan : +10 ÷ +60 °C heater : -30 ÷ -10 °C	fan : +40 °C heater: -5 °C	Skipped if appropriate output control state different from fan / heater.
30	the penultimate output fan/heater temperature thresholds line 2 : "on" temperature threshold [°C] line 3 : "off" temperature threshold [°C]	fan : +10 ÷ +60 °C heater : -30 ÷ -10 °C	fan : +40 °C heater: -5 °C	Skipped if appropriate output control state different from fan / heater.
31	the antepenultimate output fan/heater temperature thresholds line 2 : "on" temperature threshold [°C] line 3 : "off" temperature threshold [°C]	fan : +10 ÷ +60 °C heater : -30 ÷ -10 °C	fan : +40 °C heater: -5 °C	Skipped if appropriate output control state different from fan / heater.
33	output set 2	0 / 1.2 ÷ 2.9	0	
34	set1 (& set2) discharge time if the output set2 nonzero : line 2 : set1 discharge time line 3 : set2 discharge time	5 sec ÷ 20 min	20 sec	If the output set2 zero the set1 discharge time displayed only.
35	switching mode	intelligent / circular / linear	int.	

### 4.3.4.1 Automatic Output Recognizer (AOR) Launch, No. 20

With the automatic output recognition (AOR) process, the controller can detect both the output types ( capacitor / choke, single/two/three/phase ) and their reactive power sizes itself, without having to enter them manually.

The parameter setting options are :

- **OFF** ... The AOR process is never launched automatically
- **A** ... (=Auto) The AOR process is launched automatically under certain circumstances ( see below )

Furthermore, with the third option – **Run** – you can launch the AOR process manually (if all necessary conditions are fulfilled). By this, the basic parameter setting (either *off* or *auto*) stays unchanged – *the run* is “single-shot” command only and doesn't change the AOR parameter setting.

The AOR process can be successfully launched under following conditions :

- measurement voltage, at minimum value required, is connected
- no alarm action is activated

If these conditions are met, the controller starts the AOR process :

- automatically if the AOR parameter is set to **Auto** and the controller is in the control state (i.e. it is not in the manual state); the process is automatically restarted each 15 minutes until at least one compensation section with non-zero reactive power is recognized
- if being launched manually with **the Run** command in the AOR setting

The AOR process is described in details in corresponding chapter below.

### 4.3.4.2 Manual Output Type & Power Filler, No. 21

This is not any of controller parameters – it is a tool for easy manual bulk setting of the compensation sections' (outputs) types and powers in the parameter group No. 25.

If :

- although recommended, the AOR process cannot be used for the sections recognition, and
- all of the compensation sections are of the same type, and
- the compensation sections powers are in any of the most usual ratios,

you can use *the manual output type & power filler*.

Fig. 4.8 : Manual Filler

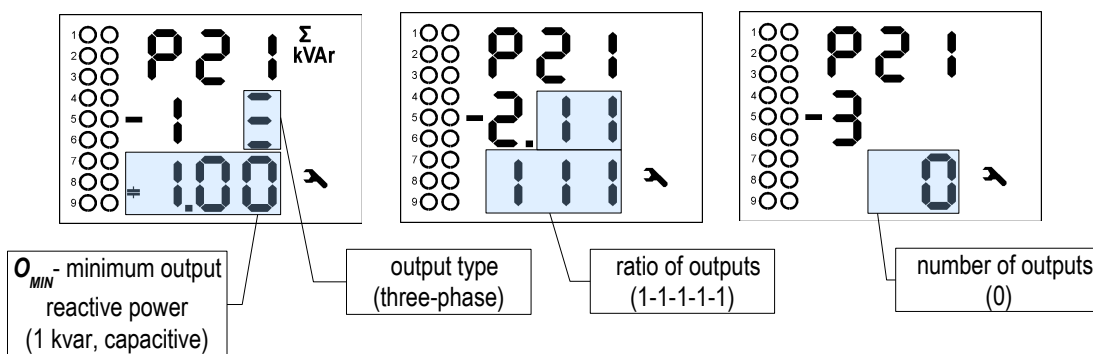

After entering into the side branch of the tool (“the parameter” 21), you can set :

- the output type and minimum (nominal) output reactive power ( $O_{MIN}$ ) in the 1<sup>st</sup> window
- the output ratio in the 2<sup>nd</sup> window
- the total number of outputs in the 3<sup>rd</sup> window

The output type and power presentation is the same as the individual output type & power in the parameter 25 – see below.

When you enter the manual filler tool side branch, the “parameters” are preset as shown on figure 4.8. Now you can edit values in the first two screens arbitrarily, but until the total number of outputs is set, no change of the outputs setup is done – if the number of outputs is set to zero, *no bulk setup is applied*.

Only when *the number of outputs* in the third screen is set to any nonzero value, *the bulk setup of outputs occurs*.

The controller fills preset number of outputs' types and powers, starting from the output No. 1.1 up, with preset type and appropriate weight of power. Powers of the outputs corresponding to weights 6 and higher are set to the same size as the weight 5. Both control and fixed outputs are filled; only the outputs preset as alarm or fan/heater control are left unaffected.

#### 4.3.4.3 Output Type & Nominal Power, No. 25

Fig. 4.9 :  
Output Type &  
Nominal Power

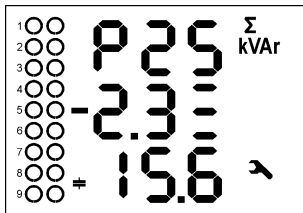

All of the sections' (=outputs') fundamental characteristics are listed at the side branches of parameters 25 ÷ 31.

The parameter group 25 contains output type and nominal three-phase reactive power of the sections.

In the side branch you can scroll through the outputs. On the example below you can see :

- output No. 2.3 just listed
- it is three-phase capacitor
- its total three-phase reactive power is 15.6 kvars

The output type character – capacitor or choke – can be toggled by editing the output power size below zero.



*During editing, the controller checks typed output reactive power value by comparing it with the instrument measurement sensitivity. If the value entered is too low, it is cut to zero.*

The output type phase specification can be changed with the **M** key. The phases covered are shown by three bars of the rightmost letter of the 2<sup>nd</sup> line – the upper bar means phase L1, the middle one phase L2 and the bottom bar phase L3. Then, the following examples explain the output type specification :

- ... type C123, three-phase capacitor
- ... type L23, two-phase choke
- ... type C1, single-phase capacitor

If an output control state is set to fan/heater control or alarm signalling (see below), its type and power are irrelevant.



*These parameters can be set automatically using the AOR process. For manual setting, the manual output type & power filler can be used too – see above.*



*If an output was detected as defective, it is marked with flashing decimal point of its power value.*



*If an output was detected and marked as defective (for details see the output error alarm description), after being edited this assignment is cancelled and the output is reincluded into power factor control process by editing any of the two parameters.*

#### 4.3.4.4 Output Control State, No. 26

The *output control* state parameter that can be set to :

- **C O n** ... (=control ) The output is used for power factor control process.
- **F I** ... (=fixed-on) After the controller being powered, the output, after preset discharge time expires, is switched on and kept permanently closed. It is not used for the power factor control process. The only case when such output is switched off is any of appropriate alarm actuation activation.
- **F O** ... (=fixed-off) The output is permanently switched off, so it is not used for the power factor control process.

During the AOR process or if circular or linear switching mode is set, the fixed outputs are taken as non-existent and they are simply skipped.

Furthermore, the upper three outputs can be set to :

- **F A n , H E A** ... (= fan, heater) The output is used for fan/heater control. Threshold temperatures are specified in parameters 29 ÷ 31.
- **A O n , A O F** .. (= alarm, active state on/off) The output is used for alarm signalling. For detailed function description see appropriate chapter below.

#### 4.3.4.5 Output Switch Count & Switch-On Time, No. 27, 28

These are not instrument setting parameters – statistics of outputs usage is displayed here :

- parameter group **27** : the output **switching operations** count since the last clearing. The value is important for connected contactor lifetime estimation and is checked by *the NS> alarm*. In case of the contactor replacement you can clear the counter by its editing and selection the **C L r** option.  
By checking frequency of switching you can tune other power factor control parameters optimally during the compensation system commissioning.  
The value is taken in account during power factor control intervention evaluation in order the contactors to be loaded as uniformly as possible.
- parameter group **28** : the output **switch-on time** since the last clearing. The value is important for connected compensation capacitor (if any) lifetime estimation. In case of the capacitor replacement you can clear the counter by its editing and selection the **Clear** option.  
The value is taken in account during power factor control intervention evaluation in order the capacitors to be loaded as uniformly as possible.

#### 4.3.4.6 Fan / Heater Temperature Thresholds, No. 29 ÷31

If any of three upper outputs are set to the fan or heater control state, these parameter groups bear specification of the temperature range when the corresponding output to be closed or open. Otherwise, the parameter group is hidden.

The relation of the parameters is as follows :

- parameter No. 29 ... the *ultimate* output thresholds (for example, output 2.9 for models „2618“ )
- No. 30 ... the *penultimate* output thresholds (output 2.8)



- No. 31 ... the *antepenultimate* output thresholds (output 2.7)

For other models, the relation is analogous : for example, for the “2607” models, corresponding outputs are 1.7/ 1.6 / 1.5.

The parameter group contains :

- switch-on threshold in line 2, marked with symbol ▲
- switch-off threshold in line 3, marked with symbol ▼

Fig. 4.10 :  
Heater Temperature  
Thresholds

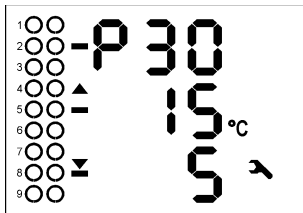

On the example at left we can see :

- thresholds for the penultimate output (probably set as heater), i.e. the output 2.8 for „2618“ models
- the output 2.8 will be closed as soon as temperature drops down to -15°C
- the output 2.8 will be opened as soon as temperature reaches -5°C

#### 4.3.4.7 Output Set 2, No. 33

With this parameter you can divide the controller outputs into two so called “sets”. Then some output parameters can be specified individually for each of the sets.

As default, the **Set 2** parameter is **Off**. In such case all of outputs are comprised into *set 1* and *the set 2* does not exist.

The *output set 2* parameter can be set to any outputs from No. 1.2 up. If, for example, set to the output No. 1.7, two sets are defined :

- **set 1** comprises 6 outputs from No. 1.1 through 1.6
- **set 2** comprises outputs from 1.7 up, i.e. remaining (at maximum) 12 outputs No. 1.7 through 1.9 and 2.1 through 2.9

In other words *the set 2* parameter defines beginning output of the set 2.

For now, only *the discharge time* parameters can be set individually for the two sets. There can be more of such parameters in the next firmware versions.

#### 4.3.4.8 Discharge Time for Output Set 1 / 2, No. 34

All of capacitor-character outputs are protected against early reconnection for preset discharge time after being switched off. During this time, the control process lets such outputs off and even manual attempts for closing such outputs are blocked.

As default, the *output set 2* parameter (see below for details) is off. Then, *the discharge time for output set 1* is relevant only and used for all of outputs. *The discharge time for output set 2* parameter is not displayed at all.

If *the set 2* parameter is active, two discharge times are displayed :

- discharge time for output set 1 in line 2
- discharge time for output set 2 in line 3

A discharge time is displayed in format “MM.SS” (minutes.seconds).

### 4.3.4.9 Switching Mode, No. 35

In most of applications it is recommended to let the controller to use the compensation steps during power factor control process without any limitations. In such case, it optimizes usage of the outputs in order to reach maximum whole compensation system lifetime.

In special cases you can force the controller to keep particular sequence of outputs' switching with *the switching mode* parameter setting :

- **I n t** ... (=intelligent) No limitation for the switching sequence. The controller uses the outputs optimally. Default, recommended for most of applications.
- **C i r** ... (=circular) In this mode the controller connects or disconnects compensation sections in the circular fashion, which means:
  - always the output that was disconnected first (i.e. that is disconnected for the longest time) is connected first
  - always the output that was connected first (i.e. that is connected for the longest time) is disconnected first

This switching mode can be usually used only if compensation outputs of the same type and power, otherwise power factor control process will not work optimally

- **L i n** ... (=linear) In this mode the controller connects or disconnects compensation sections in the linear fashion, which means:
  - always the lowest in order not yet connected compensation section(s) is/are connected
  - always the highest in order connected compensation section(s) is/are disconnected

This mode is determined for harmonic filters control. It is strongly recommended not to activate linear switching mode at standard power factor compensation applications, otherwise quality of control process will be decreased !

The sections with non-zero reactive power only that are *not permanently connected or permanently disconnected or used for alarm, fan or heater control* are considered compensation sections involved in the control process ( "control sections" ). That means that for both circular and linear switching modes, when the controller selects next sections to be switched on or off, the remaining „non-control sections“ are simply skipped.

When selecting the linear switching mode, the AOR is disabled and cannot be launched on - the sections' types and powers must be set manually.



### 4.3.5 PFC Alarm Parameters

The controllers evaluate various nonstandard conditions ( such like measured quantities' extreme values ) and, by the PFC alarm setting, various *alarms* can be activated.

Each of the alarms has two functions :

- alarm indication ( **I** )
- alarm actuation ( **A** )

If **the alarm indication** is set and appropriate alarm condition keeps fulfilled for preset time, the alarm indication gets active which means :

- flashing alarm symbol  appears on a display. Then in alarm setup parameters you can look up the alarm event which activated the alarm : scroll through parameters 40 ÷ 56 and you can detect the alarm source according lit symbol  - in the alarm setup parameters,

flashing general alarm symbol is replaced with permanently lit or hidden alarm symbol indicating current active/passive state of the listed alarm.

- if any of outputs is set as alarm output, the appropriate output switches to preset active state. (on/off) according the parameter 26 setup

Unlike alarm actuation described below, the alarm indication function has no effect on the PFC control process.

For most of the alarm events, you can set **the alarm actuation** function too. The actuation means intervention in the control process, mostly interruption of controller operation, usually with subsequent disconnection of all compensation sections.

For phase-type control quantities (see further below), the alarm actuation works selective : if an alarm condition appears at, say, phase L2 only, only compensation sections that have non-zero reactive power component of L2-phase are disconnected. Other sections, such like C1, C3, C13 etc. type sections (that have zero L2 reactive power component ) are not affected by the alarm activation and they still stay used for power factor control process.

The PFC alarm setup group starts at parameter group No. 40, see table *PFC Alarm Setup – Overview of Parameters*. The alarms are referenced with :

- *alarm number* ... range 01 ÷ 17, for example the voltage loss alarm number is 01
- *alarm mark* ... for example the  $U \ll$  means voltage loss alarm

You can scroll through all the alarms and check their main setup and actual state. In the side branch of each of alarm parameter group there are four subparameters as shown on example on figure 4.11.

Fig. 4.11 : PFC Alarm Setup – I< Alarm

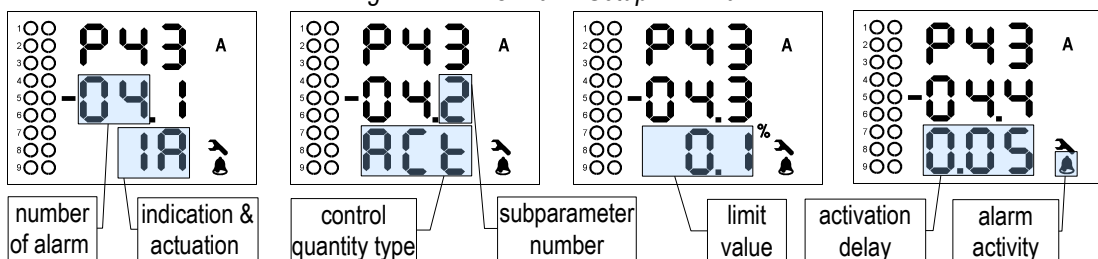

Parameter group No. 43 is *the undercurrent alarm* ( mark "I<"). Its number 04 is displayed in the first two characters of line 2. The third character is number of the alarm subparameter :

- 1 ... alarm indication and actuation setting :
  - - - = neither indication nor actuation processed (switched off)
  - I - = indication is processed only (set on)
  - - A = actuation is processed only
  - I A = both indication and actuation are processed
- 2 ... control quantity type :
  - **ACT** = *actual* value (I, for example discussed) of the control quantity is used for the alarm condition evaluation
  - **AUG** = *average* value ( $I_{AVG}$ ) is used
- 3 ... the alarm condition limit. Usually in percent of a nominal value. In the example it is set to 0.1 % of the  $I_{NOM}$ . For some alarms, it does not exist at all.
- 4 ... activation delay - minimum duration of continuous alarm condition occurrence before the alarm state gets active. With certain exceptions that applies for both activation and deactivation. Expressed in format *minutes.seconds* .

Tab. 4.5 : PFC Alarm Setup – Overview of Parameters

#	alarm No., mark	alarm event	control quantity / event	limit setting range	activation (/ deact.) delay	default v. Indication, Actuation	notes
40	01 <b>U&lt;&lt;</b>	voltage loss	$U_{LN}$ (1 period)	20% of $U_{NOM}$ (fixed)	0.02 sec / 5 sec (fixed)	- <b>I + A</b>	simult. disconnection
41	02 <b>U&lt;</b>	undervoltage	$U_{LN}$ / $U_{LNAVG}$	20÷100% of $U_{NOM}$	1 sec ÷ 20 min	$U_{LN}$ / 70 % / 1 min	
42	03 <b>U&gt;</b>	overvoltage	$U_{LN}$ / $U_{LNAVG}$	100÷200% of $U_{NOM}$	1 sec ÷ 20 min	$U_{LN}$ / 130 % / 1min	
43	04 <b>I&lt;</b>	undercurrent	$I$ / $I_{AVG}$	0÷25.0 % of $I_n$ *)	1 sec ÷ 20 min	$I$ / 0.1 % / 5 sec <b>I + A</b>	fixed sections not affected by actuation
44	05 <b>I&gt;</b>	overcurrent	$I$ / $I_{AVG}$	100÷140 % of $I_n$ )	1 sec ÷ 20 min	$I$ / 120 % / 1 min	indication only;
45	06 <b>CHL&gt;</b>	CHL limit exceeded	CHL / $CHL_{AVG}$	80÷300 %	1 sec ÷ 20 min	CHL/133 % / 1min	
46	07 <b>THDU&gt;</b>	THDU limit exceeded	THDU / $THDU_{AVG}$	1÷300 %	1 sec ÷ 20 min	THDU /10 % / 1min	
47	08 <b>THDI&gt;</b>	THDI limit exceeded	THDI / $THDI_{AVG}$	1÷300 %	1 sec ÷ 20 min	THDI / 20 % / 1min	
48	09 <b>P&lt;</b>	P limit underflown	Pfh / $Pfh_{AVG}$	0÷99 %	1 sec ÷ 20 min	0 % / 5 sec	
49	10 <b>PF&gt;&gt;</b>	PF control failure - PF control deviation out of contr. b'width	$\Delta Q_{fh}$ / $\Delta Q_{fh_{AVG}}$	-	1 sec ÷ 20 min	$\Delta Q_{fh_{AVG}}$ / 5 min <b>I</b>	indication only
50	11 <b>NS&gt;</b>	number of switching operations exceeded	number of switching operations	1÷9999 thousands	immediat. (0 sec)	100 <b>I</b>	indication only
51	12 <b>OE</b>	output error	section failure	0÷99 % of reading; 0÷10 % of range	3 ÷ 15 consecut. occurrences	20 %; 0.1%; 10 <b>I + A</b>	
52, 53	13 <b>T1&gt;&gt;</b> 14 <b>T2&gt;&gt;</b>	temperature exceeded / drop	$T_i$ (internal)	-40 ÷ +60 °C	1 sec ÷ 20 min	>+45 °C / 1 sec >+35 °C / 1 sec	
54	15 <b>EXT</b>	external alarm active	digital input state	-	0.02 sec / 5 sec (fixed)	-	simult. disconnection
55	16 <b>OoC</b>	out of control	PF control process not running	-	1sec ÷ 20min / imm'tely	15 min	indication only
56	17 <b>RCF</b>	remote control failure	remote control process state	-	1sec ÷ 20min / imm'tely	1 min	indication only

Notes : \*)  $I_n$  ... CT secondary rated current; 5A or 1A according the CT-ratio setup

Alarm indication can be set or switched off. For most of the alarms you can set the actuation too.

Alarm actuation usually causes disconnection (step-by-step ) of all of affected compensation sections, including the fixed ones. Due to this the controller gets into standby state. Exceptions of this rule are listed in individual alarm overview below.

Permanently lit or hidden alarm activity symbol  indicates alarm condition being just active.

### 4.3.5.1 Standard Type Alarms

Standard type alarms are controlled by appropriate control quantity – you can usually choose either actual value or averaged value (for the quantities description, see the meter block chapter further below).

Then you can set the quantity limit and the alarm reaction delay; it is mostly valid for both activation and deactivation.

The standard type alarms are :

- **U<** ... undervoltage alarm
- **U>** ... overvoltage alarm
- **I<** ... undercurrent alarm
- **I>** ... overcurrent alarm
- **CHL >** ... CHL limit exceeded alarm
- **THDU >** ... total harmonic distortion of voltage alarm
- **THDI >** ... total harmonic distortion of current alarm
- **P<** ... active power drop alarm
- **PF><** ... PF control failure alarm

There are following exceptions in the standard type alarms behaviour :

- **I<** ... When the undercurrent actuation gets active, fixed sections stay unaffected.
- **I>** ... Overcurrent alarm indication can be set only ( no actuation function ).
- **P<** ... Function can be set to signed or unsigned control quantity value to be evaluated in the same way as *the tariff 2 control power* parameter (see above). Depending on this, either standard value or absolute value of active power value is compared with the preset limit.
- **PF><** ... Power factor control deviation  $\Delta Q_{fh}$  is checked for the PF control alarm. But there is not any presetable limit; the alarm gets active as soon as the PF control deviation exceeds actual control bandwidth (usually one half of the reactive power value of the smallest output) for preset delay time.

The alarm has no actuation function.

### 4.3.5.2 Fast Actuation Reaction Alarms

These alarms have special common features :

- actuation reaction time is 20 ms (fixed)
- affected outputs are disconnected immediately ( during 20 milliseconds ) and all at once (not step-by-step)

- deactivation delay of the actuation is 5 seconds (fixed)

The fast alarms are :

- **U<<** ... measuring voltage loss alarm. Both the alarm limit and the alarm control quantity are fixed – 20% of preset  $U_{NOM}$  voltage and the actual  $U_{LN}$  phase ( line-to-neutral ) voltage, respectively – they cannot be changed.
- **EXT** ... external alarm. The alarm gets active as soon as appropriate voltage ( see tech. specifications) is applied to the instrument's digital input terminals. It can be used only at controller models equipped with the digital input, of course.

### 4.3.5.3 NS> - “Number of Switching Operations Exceeded” Alarm

You can use this alarm for contactors wear-out indication.

The indication limit can be set in subparameter No. 3 – either in thousands (with **k** symbol) or millions (**M**) of switchings. Number of switching operations of individual outputs are checked permanently and as soon as any of the outputs exceeds preset limit, the alarm indication gets active.

After the contactor replacement, the corresponding output switching counter can be cleared manually.

The alarm has no actuation function.

### 4.3.5.4 OE - “Output Error” Alarm

This alarm is intended for faulty section indication and disablement.

If at least the alarm indication is set, the controller continually checks reactive power changes in the power system during the control process as the sections are connected and disconnected and compares them with each section's power preset in its memory. All of the single -phase reactive power components are checked individually.

If connecting and disconnecting a section does not repeatedly result in adequate change to reactive power in the power system (or a change to reactive power measured is very different from the section power value), the controller tags such a section as faulty and, if the alarm actuation has been set too, it will disable the section and stop using it in further compensation temporarily. Such section is tagged with flashing decimal point of its reactive power value in the parameter 25.

If the alarm actuation is not set, the controller will only tag the faulty section, trigger alarm indication, but will keep using the section in compensation process.

Fig. 4.12 : PFC Alarm Setup – OE Alarm

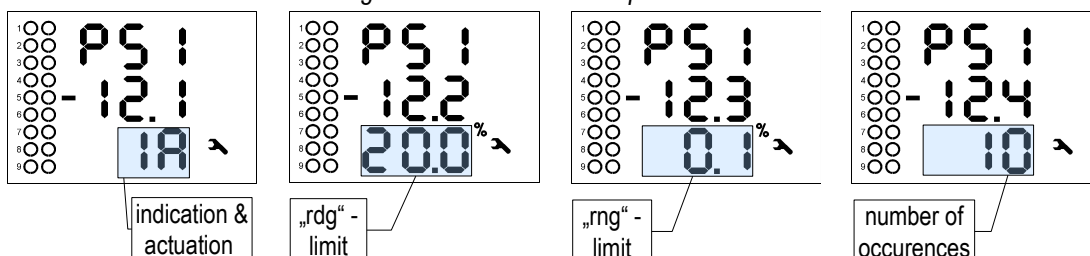

Excluding the indication and actuation, following parameters can be set :

- **Limit – rdg** ... maximum allowed single-phase power difference component in percent of the power value (“reading”); default value is 20%

- **Limit – rng** ... maximum allowed single-phase power difference component in percent of the instrument maximum rated reactive power range; default value is 0.1% .
- **“Delay”** ... minimum number of consecutive following out-of-tolerance measurement events of the same tolerance polarity to force the alarm active (number of switchings on/off); default value is 10 occurrences

The output single-phase power difference tolerance is equal to sum of the rdg- and the rng-components. For example, for the alarm setting above, if the three-phase output power is 10 kvars (i.e. corresponding single phase power is 3.33 kvars):

- the single-phase rdg-component is  $10000 / 3 \times 0.2 = 667$  vars
- the single-phase rated reactive power range excluding CT-ratio is  $400 \times 5 = 2000$  vars (Unmax = 400V, Inmax = 5A); for CT/ ratio, say 500/5 A, the rated range is 200 kvars. Therefore, as the rng-component is set to 0.1% it corresponds to 200 vars
- total output difference tolerance of each phase power is  $667 + 200 = 867$  vars

That means if the controller detects the output phase power size approximately lower than  $3333 - 867 = 2466$  vars or higher than  $3333 + 867 = 4200$  vars it classifies the output power out of tolerance.

If preset number of consecutive out-of-tolerance detections of particular section with the same tolerance polarity occurs, i. e. the output response was continuously lower (or higher) for preset times, the alarm gets active; the output is tagged and - depending on the alarm setting - it is disabled too.

The section that has been temporarily disabled is periodically, about every four days, checked by including it in compensation for one switching operation. If the controller detects a relevant response in the power system (within adequate allowance) to connecting the section, it will include the section back in the control process again. In this way, for example, a repaired section is automatically included in compensation (after replacing section fuse, for instance).

If the controller does not put a disabled section back to compensation automatically, such reinclusion in the control process will take place in the following situations:

- power supply interruption or controller initialization
- editing the section's type or the section's value (in parameter 25)
- new automatic output power recognition (AOR) process

#### 4.3.5.5 T1>< (T2><) - “Temperature Exceeded/Drop” Alarm

These two fully independent alarms use temperature as their control quantity. So called *internal temperature*  $T_i$  is used. This temperature is measured with the sensor which is built inside the instrument.

The alarm functionality is similar to the standard type alarms. The only difference is that you can set not only the threshold temperature ( limit ) but the polarity of its deviation - ▲ or ▼ - too with the **M** key. Therefore, the alarm can be activated by both overheating ( > limit, ▲ ) and overcooling ( < limit, ▼ ).

#### 4.3.5.6 OoC - “Out of Control” Alarm

This alarm can be used for signalling of states when power factor control doesn't run. Such states can be :

- the controller is switched into the manual state

- the controller is switched into the control state, but power factor control process doesn't take place due to any cause such like :
  - the instrument is forced into *the standby* state ( see below for details )
  - automatic output recognition (AOR) process in progress
  - the CT connection test in progress

If such state lasts continuously for preset delay time, the alarm gets active. As soon as the power factor control process resumes the alarm is deactivated immediately.

### 4.3.5.7 RCF - “Remote Control Failure” Alarm

This alarm will serve for remote control problem signalling in future. Now it is not functional.

## 4.4 Instrument Operation

After powerup, initial test runs first. During this, the manufacturers logo is displayed momentarily.

After the test the controller returns into one of two main states corresponding to the state last state set ( the last state is registered in non-volatile memory )

- **Control state** ... The instrument performs power factor control process; if, for some reason, it can not perform it, it gets into *the standby* state temporarily.
- **Manual state** ... the instrument does not perform power factor control process; manual output manipulation is allowed for testing purposes.

Fig. 4.13 : PFC Controller Main Operating States

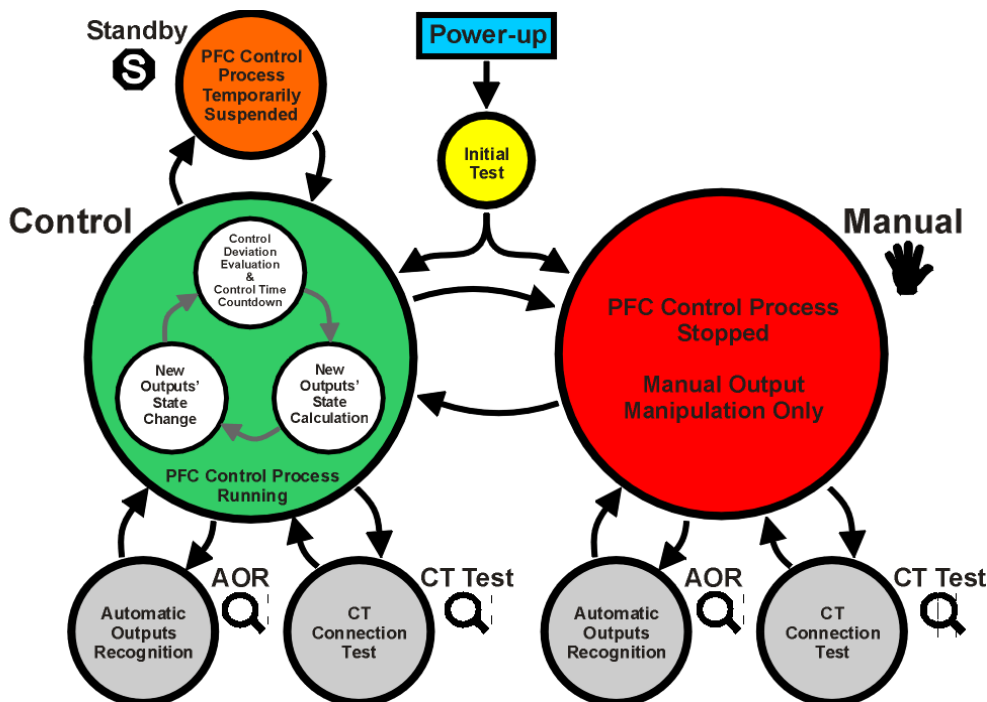





## 4.4.1 Control State

In the control state, the controller carries out its standard task – the power factor control process. The process consists of three basic steps performed over and over again :

- evaluation of reactive power control deviation and, depending on its magnitude, control time countdown
- as soon as the control time expires, new combination of outputs is calculated
- then the new combination is applied to the outputs

This sequence can be temporarily suspended due to either operator manual intervention or automatically by the controller for some reason. Then the controller can get temporarily to one of following „substates“ :

- *standby state* ( indicated with flashing  )
- *automatic output recognition (AOR) process* ( flashing  )
- *CT connection test* ( flashing  )

### 4.4.1.1 Control Time, Parameter No. 65

In the control state the power factor control passes discontinuously as a sequence of *control interventions*. The period between two consecutive control interventions is called *control time*.

Depending on preset *control strategy* ( parameter 11, see above), one control time only or more times are counted down. If the **3p** or **3p+1p** strategy is set, one common (“three-phase”) control time is evaluated. For the **3x1p** strategy, three individual control times for each independently controlled phase are evaluated.

As soon as the control deviation exceeds one half of appropriate smallest output power, the control time counter is filled with appropriate preset control time value (depending on the deviation polarity) and starts to count down. At the same time, appropriate control time bargraph starts to grow to the right. Over time, the control deviation flag field background is fully filled, that means that the control time counter has expired. Just after that new control intervention occurs and the control process continues again from the beginning.

If the control deviation drops down below one half of the smallest output power, the control time counter is refilled with the preset control time and the countdown stops. But there are two exceptions to this – if :

- either at least one control choke (or, generally, inductive character section) is switched on,
- or there is very low load in the network

the control time counts down at minimum rate even during balanced state.

Actual state of the control time in seconds can be checked in the parameter 65. If more control times are processed, the minimum value of the control time counters is displayed. In balanced state the - - message is displayed.



*Unlike other parameters, when the control time parameter (No. 65) is displayed the controller **does not go into the stanby** mode, but it goes on the PFC control process (if not forced into the standby by other cause). Furthermore, automatic return into the measured values display occurs not during 30 seconds but after about 5 minutes only.*

## 4.4.2 Standby State, Standby Cause Parameter No. 66

There can be various reasons causing the controller goes to the standby state, indicated in the parameter 66 :

- fundamental component of measuring voltage or current is below the instrument sensitivity causing that power factor cannot be evaluated; this is indicated with the  $U = 0$  or the  $I = 0$  message
- no control section (output) available ( all of the sections have zero reactive power or are set as fixed sections ); indicated with the  $C = 0$  message
- control sections are forced off due to active actuation of any alarm; in such case the  alarm symbol and the **ALA** message flashes
- the controller display switched to parameters ( temporarily, excluding the parameter 65); no particular message appears

The standby cause can be checked in *the parameter 66* (i.e. this is not instrument setting parameter). The messages are displayed in lines 2 and 3 of the parameter 66. If more than two causes active only the first two of them are listed. If no cause active, the  $- - -$  message is displayed.

As soon as the events causing the standby state pass, standard power factor control process resumes automatically.

## 4.4.3 Manual State

For testing purposes, especially during the first controller installation, you can switch the controller into the manual state. Push keys **P** and **M** and hold them down simultaneously for about 6 seconds until the  symbol starts flashing.

During the manual state no power factor control takes place, the outputs' stay in the last state when the manual state was entered to. They are restored into this state even after a power failure. But the outputs can be temporarily switched off due to any alarm actuation if appropriate event occurs.

During this state, you can manipulate with the outputs manually. Press key **P** and instead the instrument parameters, the state of the output 1.1 appears :

Fig. 4.14 : Manual State Output Manipulation

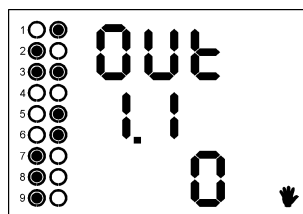

In the first line there is the **OUT** message. With the keys  $\blacktriangle$ ,  $\blacktriangledown$  you can scroll through all the outputs (usually from 1.1 to 2.9, the output number in line 2) and check the output actual state in line 3 (0=off, 1=on).

To change an output state, edit it like the instruments' parameters. The outputs' states change while being edited, respecting the reconnection delay time specified – until it expires the output symbol flashes.

After the testing finished, switch the controller back into the control state using the same procedure as when entering the manual state.



*You can not view or edit the controller's parameters in the manual state – you can only close or open each of the controller's outputs.*

## 4.4.4 Automatic Output Recognition (AOR) Process, Parameter No. 20

The controller can recognize types and sizes of compensation capacitors or chokes connected to its outputs automatically using this process.

If the *automatic output recognizer* parameter is set to *auto*, the controller launches this process automatically if :

- it is switched into the control state and is not in the standby state
- none of the control compensation outputs is specified at a non-zero power (all of the control outputs reactive powers are zero)
- a measured values screen is displayed

In the control state the process can be started manually too. For this, scroll to the parameter 20 (AOR) and edit its value to **run**.

If any chokes are used in the compensation system, the *Choke Control* parameter must be set first; otherwise, all of chokes (or any inductive character type outputs) will be recognized as zero outputs.



*Sometimes it is necessary to start the AOR process at disconnected load (or at zero load) – for example, when testing a compensation switchboard before its expedition to a customer. If the default controller undercurrent ( $I<$ ) alarm (No. 04, parameter 43) actuation is set the controller gets into the standby state in such case and the AOR process cannot be started. Therefore, it is necessary to switch this alarm actuation temporarily off (and to return it back after the AOR-process passes).*

After being started, switch to display of measured values with the **M** key (or it occurs automatically during about 30 seconds). Then, the AOR screen appears : the **AOR** message in the first line and the symbol **Q** flash.

First of all, all of control outputs (i.e. excluding the fixed ones and optional alarm/fan/heating ones) are disconnected, step by step.

Then the instrument waits until discharge time of the outputs just disconnected expires - such not-discharged outputs are identified with flashing output symbol. That means that the instrument waits till output No. 1.1 is ready to use.

Fig. 4.15 : AOR-Process Step 1.1 Recognition Example

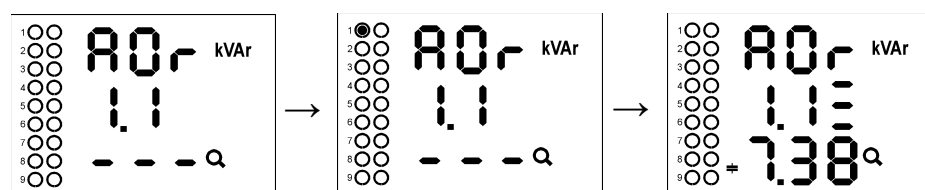

After all of the outputs discharged, the instrument starts to switch the outputs step by step. The number of a step is displayed in the second line and appropriate output is switched on for a short time. After the step is switched off, its type and size is displayed :

- three-phase reactive power of 7.38 kvar, capacitive, in the third line
- in the second line (behind the output number) type of the capacitor – three-phase type (C123) because of all of three bars displayed behind the step number



*Note : The recognized output powers are not displayed as actual power values but **the nominal power** values, that is the values that correspond to the preset nominal voltage  $U_{NOM}$  of the network.. It is supposed that the metering current transformer ratio and the metering voltage transformer ratio, if any, are set correctly.*

If a step power was detected as zero, either the output is not used (nothing connected to it) or the step power is too small to be recognized automatically.

If the controller does not succeed in determining a output's value, it does not show it – dashes - - - are displayed instead. This condition occurs if reactive power value in the power system fluctuates considerably due to changes in load.

The process has 3 or 6 rounds – round number is displayed momentarily at the beginning of the round in the first line.

After carrying out three rounds, partial evaluation is carried out. If measurements in the rounds carried out provides sufficiently stable results, the AOR process is completed. Otherwise the controller carries out up to three more rounds.

A requirement for successful AOR process is sufficiently stable condition of the power system – while connecting or disconnecting a section, the reactive load power must not change by a value which is comparable with, or even greater than, the reactive power value of the section under test. Otherwise the measurement result is unsuccessful. As a rule of thumb, the section values are recognized the more precisely, the lower the load is in the power system.

Ongoing AOR process can be cancelled at any point either manually by switching display into parameters with the **P** key or by any of alarm actuations. In such case, the recognized data are neglected and output setting is not updated.

On completion of the total process, the controller saves recognized output types and sizes into its memory. Then , if at least one section with non-zero total reactive power has been detected, the controller starts power factor control.

Otherwise, if the previous AOR process unsuccessful (no valid outputs found or cancelled prematurely), the process is automatically relaunched each approximately 15 minutes again in the control mode.



*It is strongly recommended to check recognized section values in parameter 25 after the AOR process has passed. If any doubt about the recognized values you can start the AOR process again or, if necessary, to edit the section values manually. It is often necessary at the lowest power sections especially when the AOR process run while high load at the network – such sections can be recognized as zero outputs and needs to be set manually.*



*If the undercurrent (  $I_K$  ) alarm ( No. 04, parameter 43 ) was disabled for the AOR-process to be able to pass without any load in the network do not forget to reenable it back !!!*

## 4.4.5 CT Connection Test, Parameter No. 81

For proper instrument operation, right current inputs' connection is crucial requirement. The inputs' phase order must correspond to connected voltage signals and, furthermore, their polarity must respect orientation of used current transformers (k/I terminals).

The CT connection test is simple tool for right current transformers' connection analysis. It uses the first four compensation outputs for detection of individual phase current angles. The only condition must be fulfilled for the CT test usage : either **three-phase** or **single-phase** compensation **capacitors** are connected to **the first four control outputs**. If, for example, two-phase capacitors or any chokes connected to the outputs, the CT test gets fail results !



*If inappropriate compensation elements connected to the first four outputs, you can set such outputs temporary to **the fixed-off** control state; then the instrument will use for the CT test the next four outputs that are set as **the control** outputs.*

The CT test can be launched manually only from "the parameter" 81 by editing of its value to **rUn**. After being started, switch to display of measured values with the **M** key (or it occurs automatically during about 30 seconds). Then, the CT-test screen appears : the **CTT** message in the first line and the symbol **Q** flash.

First of all, the first four of control outputs are disconnected, step by step. Then the instrument waits until discharge time of the outputs just disconnected expires. During this, output number **1.1** (for example ) in the 2<sup>nd</sup> line and appropriate output symbol flash, that means that the instrument waits till output No. 1.1 is ready to use.

When the outputs used for the testing are discharged, the instrument starts to switch the outputs step by step. After each of the step is switched off, the result of reactive and active powers and evaluated current signal angle of individual phases appears at the bottom line. If the measurement is not successful, dashes appear instead the test results ( this is not unusual that such results appear, especially if high power load in the network or if the powers of outputs that are used of testing are low, compared to the network load ).

Fig. 4.16 : CT Test Window

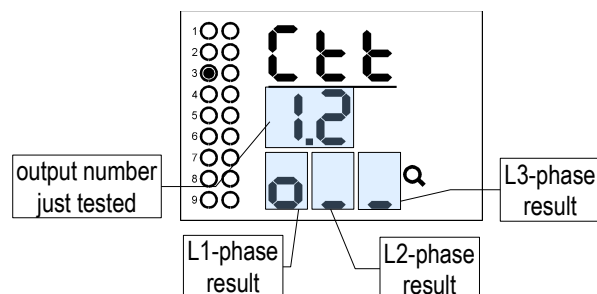

The test can have up to six rounds with four testing steps each. After each step, the measurement results of individual phases are analyzed. If the results of any phase is sufficiently stable, detected current signal connection information is shown in the 3<sup>rd</sup> line, as can be seen in the picture above in the L1 phase result. The connection information can be one of following :

Tab. 4.6: CT Test Results

CT connection test result	meaning	action required
	correct connection (both phase and polarity)	none
	correct phase, reverse polarity	swap the current input wires
	wrong phase, correct polarity	move wires to <b>the next</b> phase current input, keep the polarity
	wrong phase, correct polarity	move wires to <b>the previous</b> phase current input, keep the polarity
	wrong phase, reverse polarity	swap the wires and move them to <b>the next</b> phase current input
	wrong phase, reverse polarity	swap the wires and move them to <b>the previous</b> phase current input
	unsuccessful measurement	recheck the connection

As soon as the connection detected at all of phase inputs, the CT test finishes. If all of current signals connected correctly the test result looks like this :

Fig. 4.17 : CT Test Result – All of the Inputs Connected Correctly

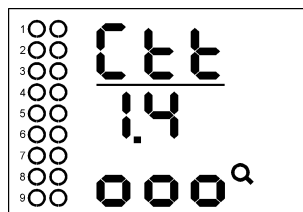

Then you can close the window by pressing of any key, otherwise the window closes automatically after about 30 seconds delay.

If the inputs are not connected correctly, the CT test result can look, for example, like this :

Fig. 4.18 : CT Test Result – the L2 and L3 Inputs Wrong Connected

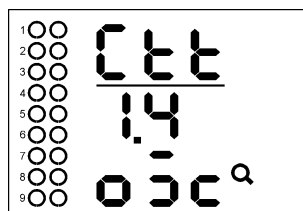

In such case it is necessary to reconnect the current signals :

- let the L1 input unchanged
- disconnect the wires connected to the instruments L2 input, swap them and connect to the L3 input
- disconnect the wires connected to the L3 input and connect them to the L3 input (while keeping their polarity)

Then launch the CT test again to be sure the intervention was successful.



*If polarity of all of current inputs correct and there is necessary to move two or three inputs to another phase it is usually simpler to move appropriate voltage inputs instead, because you need not to short-circuit the CT outputs, there is only one wire at each voltage input and they can be usually simply temporary disconnected with front-end protection fuses or breakers.*

If the instrument does not succeed in the detection of connection of any of phases even after the sixth round pass, the test is finished with unsuccessful measurement result (  ). It could occur due to various causes :

- considerable power fluctuations in load during the test; start the test again when the load is more stable
- reactive powers of compensation elements connected to the first control outputs are too low in compare with actual network load; start the test again after the load drops down or set the outputs temporarily to the fixed-off state to force the controller to use other outputs with higher power
- compensation elements connected to the first control outputs are not single-phase or three-phase capacitors; try the same modification as in the previous point
- if, for example, single phase capacitors of C1 and C2 type only are connected to the outputs, the connection cannot be detected in the L3 phase; try the same modification as in the previous point

Ongoing CT test can be cancelled at any point either manually by pushing the **P** key or by any of alarm actuations.

## 4.4.6 Manual Intervention in Control Process

In order to be able to check the controller's response to a control deviation change, it is possible to connect or disconnect a section by operator's manual intervention, not only in the **Manual** mode but also within the automatic control process.

While holding key **M** pressed down you can connect or disconnect a section using keys **▲** and **▼** and watch the controller's response to the change of condition. Each button press connects or disconnects one compensation section, always the one with the smallest value (exception: in the circular or linear switching mode the order of connecting/disconnecting is specified in description of parameter 35). Reconnection delay time is respected when connecting.

If the controller is left in the automatic control mode, it will carry out evaluation and control intervention after the control time has elapsed thus putting the unbalanced conditions in the power system back to a compensated state.

## 4.4.7 Power Factor Block Factory Setting

In some situations it may be necessary to put the controller back to its default settings with which it is shipped. You can do this using *the power factor block factory setup*. After the setup has been done, the initial test starts too, that means the controller carries out all the operations as if the power supply voltage is introduced.

The PFC control and PFC output parameters are set to the default according tables 4.7 and 4.8 below. The PFC alarm parameters are set to default values according appropriate table above. General meter parameters remain unchanged.

You can start the controller initialization by pressing keys **M**, **P** and **▼** simultaneously and holding them down for about 6 seconds. The controller will first disconnect all sections connected and run the initial test – this is when you can release the buttons. Then it will carry out the initialization routine and since parameter 20 is set to *Auto* and output powers not defined now, it will start the AOR process.

Tab 4.7 : Control Parameters

Default Setup

parameter	default setup
target PF 1 / 2	cos; 0.98
control bandwidth 1 / 2	(cos) 0.010
control time – undercomp. 1 / 2	3 minutes
control time – overcomp. 1 / 2	30 seconds
offset power 1 / 2	0 kvars
tariff 2 control	off
tariff 2 control power	0 %
control strategy	3p+1p
choke control	off
choke control limit	(cos) 1.00
offset control	off

Tab 4.8 : Output Parameters

Default Setup

parameter	default setup
output 1.1÷ 2.9 type / power / state	zero / 0 kvars / control
discharge time 1 / 2	30 seconds
output set 2	off
switching mode	intelligent
output recognizer	auto

## 4.5 Method of Measurement

The measurement consists of three processes being performed continuously and simultaneously: frequency measuring, sampling of voltage and current signals and evaluation of the quantities from the sampled signals.

### 4.5.1 Voltage Fundamental Frequency Measurement Method

The voltage fundamental frequency is measured continuously and evaluated every 10 seconds. Logical sum of all voltage signals is led through a low-pass filter and then processed.

The fundamental frequency output is the ratio of the number of integral mains cycles counted during the 10 second time clock interval, divided by the cumulative duration of the integer cycles.

If value of frequency is out of measuring range, such state is indicated with flashing symbol **Hz**.

### 4.5.2 Voltage and Current Measurement Method

Both voltage and current signals are evaluated continuously as required by IEC 61000-4-30, ed. 2 standard. The unitary evaluation interval, a *measurement cycle*, is a ten / twelve ( value behind slash is valid for  $f_{NOM} = 60$  Hz ) *mains cycles* long period ( i.e. 200 ms at frequency equal to preset  $f_{NOM}$  ), which is used as a base for all other calculations.



The sampling of all voltage and current signals is executed together with the frequency of 128 / 96 samples per mains cycle. The sampling rate is adjusted according to the frequency measured on any of the voltage inputs **U1**, **U2**, **U3**. If the measured frequency is in measurable range at least on one of these inputs, then this value is used for subsequent signal sampling. If the measured frequency is out of this range, the preset frequency value (  $f_{NOM}$  ) is used and measured values may be incorrect.

Effective values of voltages and currents are calculated from sampled signals over the measurement cycle using formulas (examples for phase No. 1) :

$$\text{Phase voltage (effective value) : } U_1 = \sqrt{\frac{1}{n} \sum_{i=1}^n U_{i1}^2}$$

$$\text{Line voltage (effective value) : } U_{12} = \sqrt{\frac{1}{n} \sum_{i=1}^n (U_{i1} - U_{i2})^2}$$

$$\text{Current (effective value) : } I_1 = \sqrt{\frac{1}{n} \sum_{i=1}^n I_{i1}^2}$$

where : i ..... sample index

n ..... number of samples per measurement cycle ( 1280 / 1152 )

$U_{i1}$ ,  $I_{i1}$  ... sampled values of voltage and current

The data for the longer measurements are aggregated from these measurement cycles.

Measured phase voltages  $U_1$  to  $U_3$  correspond to the potential of terminals **VOLTAGE / U1** to **U3** towards the terminal **VOLTAGE / N**.

Three current signals -  $I_1$ ,  $I_2$ ,  $I_3$  - are measured. Another current is calculated from samples of directly measured ones as negative vector sum of all measured current vectors ( Kirchhoff rule ). The calculated current is referenced as  $I_{PEN}$ . The  $I_{PEN}$  value is not displayed, it is available on a PC via communication with ENVIS program only.

### 4.5.3 Harmonics and THD Evaluation Method

Entire spectrum of harmonic components and THD is evaluated discontinuously - periodically every second from 10 / 12 mains cycles long signal according to IEC 61000-4-7 ed.2 as harmonic sub-groups ( $H_{sg}$ ).

Following quantities are evaluated :

Harmonic components of voltage and current up to 40<sup>th</sup> order :  $U_{ih1}$ ,  $I_{ih1}$   
( i .... order of harmonic component )

Absolute angle of voltage harmonic component phasor :  $\varphi_{Uih1}$

Current harmonic component phasor angle relative to phasor  $U_{fh1}$  :  $\varphi_{lih1}$

Relative angle between correspondent voltage and current phasors :  $\Delta\varphi_{i1}$

$$\text{Total harmonic distortion of voltage : } THD_{U1} = \frac{1}{U_1 h_1} \sqrt{\sum_{i=2}^{40} U_{ih1}^2} \times 100\%$$

$$\text{Total harmonic distortion of current : } THD_{I1} = \frac{1}{I_1 h_1} \sqrt{\sum_{i=2}^{40} I_{ih1}^2} \times 100\%$$

## 4.5.4 Power, Power Factor and Unbalance Evaluation Method

Power and power factor values are calculated continuously from the sampled signals according to formulas mentioned below. The formulas apply to basic type of connection – wye (star).

Active power :

$$P_1 = \sum_{k=1}^{40} U_{k,1} \times I_{k,1} \times \cos \Delta \varphi_{k,1}$$

Reactive power :

$$Q_1 = \sum_{k=1}^{40} U_{k,1} \times I_{k,1} \times \sin \Delta \varphi_{k,1}$$

where :  $k$  ... harmonic order index, odd components only  
 $U_{k,1}, I_{k,1}$  ... the  $k^{\text{th}}$  harmonic components of voltage and current ( of phase 1 )  
 $\Delta \varphi_{k,1}$  ... angle between the  $k^{\text{th}}$  harmonic components  $U_{k,1}, I_{k,1}$  ( of phase 1 )  
 ( these harmonic components of U and I are evaluated from each measurement cycle )

Apparent power :

$$S_1 = U_1 \times I_1$$

Power factor :

$$PF_1 = |P_1| / S_1$$

Three-phase active power: :

$$\Sigma P = P_1 + P_2 + P_3$$

Three-phase reactive power :

$$\Sigma Q = Q_1 + Q_2 + Q_3$$

Three-phase apparent power :

$$\Sigma S = S_1 + S_2 + S_3$$

Three-phase power factor :

$$\Sigma PF = |\Sigma P| / \Sigma S$$

Fundamental harmonic component quantities :

Fundamental harmonic power factor :

$$\cos \Delta \varphi_1 \quad (\text{or } \tan \Delta \varphi_1, \Delta \varphi_1, \text{ optionally})$$

Fundamental harmonic active power :

$$P_{fh1} = U_{fh1} \times I_{fh1} \times \cos \Delta \varphi_1$$

Fundamental harmonic reactive power :

$$Q_{fh1} = U_{fh1} \times I_{fh1} \times \sin \Delta \varphi_1$$

Fundamental harmonic three-phase active power :  $\Sigma P_{fh} = P_{fh1} + P_{fh2} + P_{fh3}$

Fundamental harmonic three-phase reactive power :  $\Sigma Q_{fh} = Q_{fh1} + Q_{fh2} + Q_{fh3}$

Fundamental harmonic three-phase power factor :  $\Sigma \cos \Delta \varphi = \cos(\arctg(\frac{\Sigma Q_{fh}}{\Sigma P_{fh}}))$

Powers and power factors of the fundamental harmonic component ( $\cos \varphi$ ) are evaluated in 4 quadrants in compliance with the standard specifications, see figure below.

Identification of consumption- supply and the character of reactive power according to phase difference

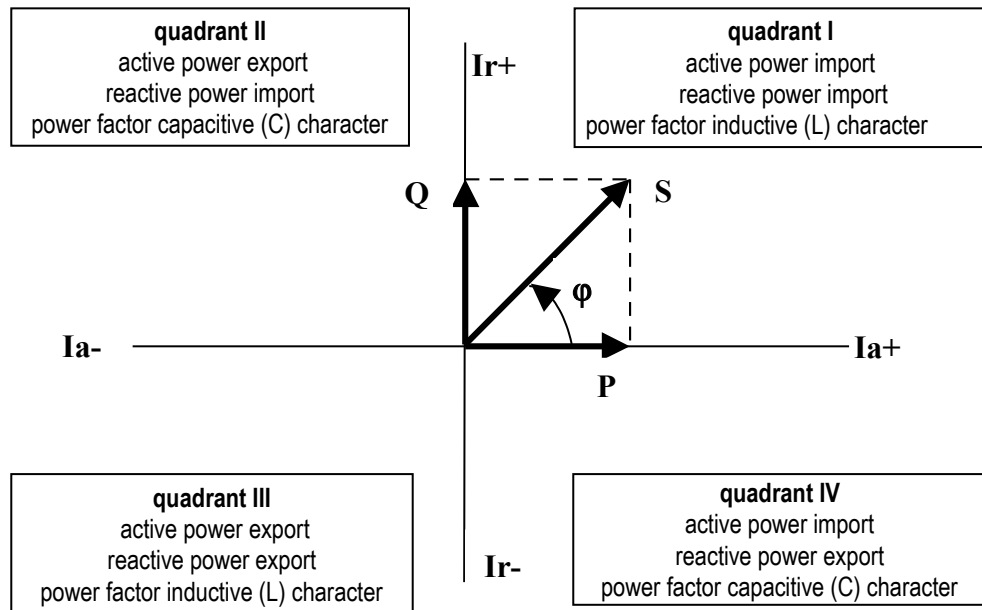

For outright specification of the quadrant, the power factor of the fundamental harmonic component –  $\cos \varphi$  – is expressed according to the graph with two attributes :

- a sign ( + or - ), which indicates polarity of active power
- a character (  $\ominus$  or  $\oplus$  ), which indicates the power factor character ( the polarity of reactive power relative to the active power )

Voltage and current unbalance evaluation is based on negative/positive sequences of voltage and current fundamental harmonic components :

$$\text{Voltage unbalance : } unb_U = \frac{\text{voltage\_negative\_sequence}}{\text{voltage\_positive\_sequence}} \times 100\%$$

$$\text{Current unbalance : } unb_I = \frac{\text{current\_negative\_sequence}}{\text{current\_positive\_sequence}} \times 100\%$$

Current negative sequence angle :  $\varphi_{nsI}$

All of angle values are expressed in degrees in range [ -180.0 ÷ +179.9 ].

## 4.5.5 Temperature

The temperature is measured with built in sensor and updated each approx. 10 seconds.

## 4.6 Measured Values Evaluation and Aggregation

As described above, measured values are evaluated according to IEC 61000-4-30 ed.2, based on continuous (gap-less), 10 / 12 mains cycles long intervals ( measurement cycle ) processing.

Further aggregation of the actual values from this evaluation is used to obtain values for displaying and recording.

## 4.6.1 Actual Values Evaluation and Aggregation

Actual ( instantaneous ) values of measured quantities, that can be viewed on instrument's display, are evaluated each *display refresh cycle* as average of integral number of measurement cycle values. The display refresh cycle is preset to 3 measurement cycles , corresponding approx. to 0.6 sec display refresh cycle duration.

Exceptions :

- frequency – the value is refreshed each frequency measurement cycle (see above)
- harmonic components, THD and unbalance – the last measurement cycle values are displayed (no averaging). Only odd harmonic components to 25<sup>th</sup> order are displayed. The unbalance is not displayed, it is available via communication link only.
- temperature – the value is refreshed each temperature measurement cycle (see above)

In this way aggregated values are passed via a communication link for monitoring purposes too.

## 4.6.2 Average Values Evaluation

From measurement cycle values, average values of all basic quantities are calculated. The averaging period in range from 1 second to 1 hour can be used.

As default, *the floating window* averaging method is applied. An internal cyclic buffer is used to store auxiliary partial averages. The buffer has depth of 60 values. If preset average period is 1 minute or shorter, partial averages of a quantity are buffered each second and new average values are updated from the preset averaging period each second. If the preset average period is longer than 1 minute, partial averages for longer duration are buffered and the average values are updated less frequently ( for example, if the preset average period is 15 minutes, partial averages are buffered each 15 seconds and average values are updated with this frequency ).

At instruments equipped with communication link, *the thermal* averaging method can be set too. An exponential function simulation is used to get the thermal dependence. Unit step time response depends on the preset averaging period – during this period, an average value reaches about 90 % of unit step amplitude.

The averaging period can be set in parameter group No. 77 independently for two groups of quantities : so called **U/I** -group and **P/Q/S** -group. Following table lists processed quantities of both groups.

*Average Values Groups*

Average values group	Averaged quantities
“ U / I ”	$U_{LL}, U_{LN}, I, f, T$
“ P / Q / S ”	$P, Q, S, PF, P_{fh}, Q_{fh}, \cos\phi$



*Preset averaging parameters noted above are valid for so called standard average values. For the maximum power demand  $\Sigma P_{avgmaxE}$  in the Electricity Meter group, separate parameter is used (see below).*

## 4.6.3 Embedded Electricity Meter

For the electric energy measurement, a stand-alone functional unit - an electricity meter - is implemented inside instruments. Except of electric energy, maximum active power demands are registered in the unit.

### 4.6.3.1 Electric Energy Processing

Measured values of electrical energy are recorded separately in six “quadrants” :

- active energy consumed (**EP+**, import), active energy supplied (**EP-**, export)
- reactive energy registered at the three-phase active energy being consumed (imported) : inductive (**EQL+**) and capacitive (**EQC+**) energy
- reactive energy registered at the three-phase active energy being supplied (exported) : inductive (**EQL-**) and capacitive (**EQC-**) energy

Both single-phase and three-phase energies are processed. But on the instrument display, only three-phase ( $\Sigma$ ) values can be viewed. Desired presentation format can be set with parameter 78.

Internal energy counters have sufficient capacity in order not to overflow during the whole instrument lifetime. On the instrument's display only 9 digits can be viewed – therefore, after energy value exceeds 99999999.9 kWh/kvarh, instrument's display format automatically switches to MWh/Mvarh, then to GWh/Gvarh.

### 4.6.3.2 Maximum Active Power Demand Registration

From the instantaneous measured values of all active powers the instrument evaluates their average values per preset period using preset averaging method – active power demands. Note that the active power demand, which is evaluated in the electricity meter unit ( $\Sigma P_{AVGE}$ ), is processed individually and its averaging period is presettable independently on standard average values. Its current value is not available on the display - only its registered three-phase maximum  $\Sigma P_{avgmaxE}$  is.

The averaging method is fixed – the floating window type. The averaging period can be set in range from 1 to 60 minutes in parameter group No. 78.

The maximums can be cleared independently of standard average maximums/minimums.

## 4.7 Special PFC-Block Related Quantities' Meaning & Method of Evaluation

General quantities' meaning and evaluation formulas can be found in the appropriate chapter. For the PFC-block operation, some additional special quantities are necessary. Description of the quantities follows.

### 4.7.1 $\Delta Q_{fh}$ – PF Control Deviation

This is crucial quantity for the PF control process. Its value indicates surplus reactive power ( of fundamental harmonic component ) in the network that must be compensated to reach preset target power factor. If the value is positive ( inductive character ) the controller connects compensation capacitors of appropriate power to the network; if negative ( capacitive character ), the controller tries to add compensation chokes.

Target fundamental harmonic component reactive power of phase L1:  $Q_{fh_{T1}} = P_{fh_1} * tg\varphi_T$

where :

Pfh1 ... phase L1 fundamental harmonic active power

$\varphi_T$  ... preset target angle between fundamental voltage and current phasors

When target power factor is specified in the  $\cos\varphi$  format it can be declared :

Target angle (between fundamental U & I phasors) :  $\varphi_T = \arcsin(\cos\varphi_T)$

Then, target fundamental harmonic component reactive power (of phase L1) is :

$$Qfh_{T1} = Pfh_1 * tg(\arcsin(\cos\varphi_T))$$

Finally, the control deviation of phase L1 :

$$\Delta Qfh_1 = Qfh_1 - Qfh_{T1}$$

where :

Qfh1 ... phase L1 fundamental harmonic reactive power

Total three-phase control deviation :

$$\Sigma \Delta Qfh = \Delta Qfh_1 + \Delta Qfh_2 + \Delta Qfh_3$$

## 4.7.2 CHL – Capacitor Harmonic Load Factor

This quantity was designed and implemented in order compensation capacitors protection against current overload to be possible simply. If appropriate alarm actuation is set the controller disconnects the sections from a network as soon as the CHL-factor exceeds preset limit value.

Compensation capacitors' service life depends on not exceeding of operation limits. One of the limits is capacitors's maximum current. This may be exceeded with voltage harmonic distortion due to a capacitor's inductance being a function of the frequency.

If voltage in not distorted (sinus), the capacitor current is

$$I_c = \frac{U}{Z_c} = \frac{U}{1/\sqrt{2\pi fC}} = 2\pi fCU \quad [A]$$

where :

Ic...	capacitor current	[ A ]
U...	capacitor voltage	[ V ]
Zc...	capacitor impedance	[ $\Omega$ ]
f...	frequency	[ Hz ]
C...	capacitor capacity	[ F ]

If the voltage is distorted, the current flowing through a capacitor forms as the sum of current harmonic component vectors

$$\vec{I}_C = \sum_{i=1}^n \vec{I}_i \quad [A]$$

and magnitude of each harmonic component is pursuant to the first formula

$$I_i = 2 \pi f_i C U_i = 2 \pi (f_i \times i) C U_i \quad [A]$$

where :

i...	order of harmonic	[ - ]
I <sub>i</sub> ...	current of i <sup>th</sup> harmonic component	[ A ]
U <sub>i</sub> ...	voltage of i <sup>th</sup> harmonic component	[ V ]

$f_i$ ... frequency of  $i^{\text{th}}$  harmonic component [ Hz ]  
 $f_1$ ... fundamental harmonic frequency [ Hz ]

According to the formula, the magnitude of current of each harmonic component is proportional to a multiple of voltage and its order ( $U_i \times i$ ) of harmonic. Consequently, the total harmonic distortion, which is defined as

$$THD_U = \sqrt{\sum_{i=2}^N \left( \frac{U_i}{U_1} \right)^2} \quad [ \% ]$$

where:

$THD_U$ ... voltage total harmonic distortion [ % ]  
 $U_i$ ..... voltage of  $i^{\text{th}}$  harmonic component [ V ]  
 $U_1$ ..... voltage of fundamental harmonic component [ V ]

is not suitable as a criterion of capacitor current overload due to harmonic distortion, because it does not respect distribution of harmonic components across their spectrum.

Therefore, the capacitor harmonic load factor is defined as follows

$$CHL = \sqrt{\sum_{i=1}^N \left( \frac{iU_i}{U_{NOM}} \right)^2} * 100 \quad [ \% ]$$

where :

$CHL$ ... capacitor harmonic load factor [ % ]  
 $i$ ..... order of harmonic [ - ]  
 $U_i$ ..... voltage of  $i^{\text{th}}$  harmonic component [ V ]  
 $U_{NOM}$ ... nominal voltage [ V ]

This factor value does respect, besides respecting each harmonic component's voltage value, distribution of harmonic components of different orders across their spectrum and it addresses the effect of voltage values. It is thus a more convenient value to determine total load of a capacitor by current. If the nominal value voltage is undistorted, this factor is at value of 100%. The following table shows CHL factor values for a few selected scenarios of harmonic distribution at fundamental harmonic component nominal value.

Tab. 4.9: Examples of CHL factor values for selected distributions of voltage harmonic components ( $U_1=U_{NOM}$ )

No.	voltage harmonic component levels [ % ]									CHL [ % ]
	3 <sup>rd</sup>	5 <sup>th</sup>	7 <sup>th</sup>	9 <sup>th</sup>	11 <sup>th</sup>	13 <sup>th</sup>	15 <sup>th</sup>	17 <sup>th</sup>	19 <sup>th</sup>	
1	2.5	3.5	2.5	1.0	2.0	1.5	0.8	1.0	0.5	110
2	3.5	4.5	3.5	1.2	2.5	2.0	1.0	1.5	1.0	118
3	5.0	6.0	5.0	1.5	3.5	3.0	0.5	2.0	1.5	133
4	5.5	6.5	5.5	2.0	4.0	4.0	1.8	2.3	1.8	146
5	8.0	9.0	8.0	6.0	7.0	7.0	2.3	4.0	3.5	208

Example 3 (CHL = 133%) corresponds to voltage harmonic distortion limits as specified in EN 50160.

### 4.7.3 RC, RL – Compensation Reserve Powers

With the compensation reserve powers RC and RL you can check if installed compensation power, i.e. total reactive power sum of all installed compensation capacitors and chokes is sufficient to keep preset target factor or not.

The reserves are defined as follows :

$$\text{Capacitive reserve power of phase L1 : } RC_1 = \Sigma Q_{COFF1} - \Sigma Q_{LON1} - \Delta Qfh_1$$

$$\text{Inductive reserve power of phase L1 : } RL_1 = \Sigma Q_{CON1} - \Sigma Q_{LOFF1} + \Delta Qfh_1$$

where :

$\Sigma Q_{COFF1}$  .... sum of L1-phase capacitive-type reactive power components of the control\*) outputs being just switched off (capacitive reactive power of an output considered as positive )

$\Sigma Q_{CON1}$  .... sum of L1-phase capacitive-type reactive power components of the control\*) outputs being just switched on

$\Sigma Q_{LON1}$  .... sum of L1-phase inductive-type reactive power components of the control\*) outputs being just switched on (inductive reactive power of an output considered as negative )

$\Sigma Q_{LOFF1}$  .... sum of L1-phase inductive-type reactive power components of the control\*) outputs being just switched off

$\Delta Qfh_1$  ..... control deviation reactive power of L1-phase



\*) The outputs that have non-zero reactive power and that are not set as fixed outputs are considered as the control outputs (including the outputs that are temporary disabled due to OE-alarm actuation).

Then, three-phase reserves are :

$$\text{Capacitive three-phase reserve reactive power : } \Sigma RC = RC_1 + RC_2 + RC_3$$



$$\text{Inductive three-phase reserve reactive power : } \Sigma RL = RL_1 + RL_2 + RL_3$$

If any reserve is positive that means that there are still one or more outputs that can switched on or off to reach target power factor in the network.

On the contrary, negative reserve means that actual control deviation cannot be compensated; the negative RC/RL value contains size of missing capacitive/inductive compensation power. That means in such case the compensation system is undersized and other capacitors/chokes should be installed.

When checking a compensation system capacity usually at least one week long period is observed.

You can use registered maximum and minimum of the reserve average values for this :

1. Check all of the compensation outputs' values and target power factor to be set properly.
2. Check and, if necessary, set suitable average method and evaluation period of the P/Q/S-group (to which the RC/RL reserves belong ; see average values setup).
3. In the actual values scroll to the  $\Sigma Q$  value (symbols  $\Sigma VAr$ , see the navigation map), then navigate to the fundamental harmonic branch with the **M** key to the  $\Sigma Qfh$  value (until the **H** symbol appears). Now , with the **▼** key switch to the control deviation  $\Sigma \Delta Qfh$  value (symbols  $\Delta \Sigma VAr$ ) and in this row navigate further right with the **M** key to the compensation reserve powers  $\Sigma RC$  (symbols  $\Sigma VAr C H$  ) or  $\Sigma RL$  (symbols  $\Sigma VAr H L$  )



4. Now, with the **M** key switch to avgmax or avgmin value of any of these values and clear up registered maximum&minimum power values : press the **M** key and keep pressed until the value starts flashing, then change it with an arrow key to the **⌈ L ⌋** and confirm with the **M** key again. Because of just cleared, undefined value - - - appears.
5. Now let the controller running for reporting period (usually at least one week). After that, check new registered maximum and minimum average values of reserve powers.

Fig. 4.19 : Compensation Reserves - Sufficient

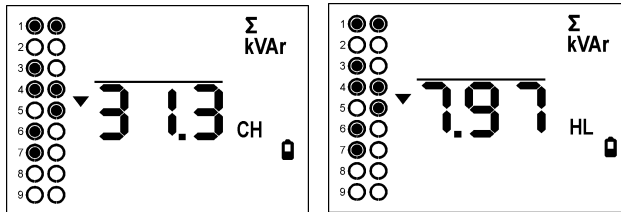
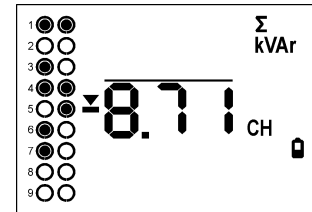

Fig. 4.20 : Compensation Reserves - Insufficient Capacitive Reserve



For compensation reactive power capacity assessment, *registered minimum values* of both reserves are decisive. On the left example above, registered minimum of three-phase capacitive reserve is 31.3 kvars, minimum of inductive reserve is 7.97 kvars. As both of them are positive the system compensation power is sufficient.

If any of reserve minimum values is negative as example on the right example shows, reactive power of magnitude that the controller could not compensate appeared sometimes in the network during the testing period. As *the ZRC* minimum average value is negative, the capacity of compensation capacitors is not sufficient ; 8.71 kvars of capacitors missed.



You can use the compensation reserves not only for checking the capacity of existing compensation system, but for any new compensation system dimensioning too : Install single instrument (without any of compensation sections connected ) at the network where new compensation system to be projected . Then perform the reserve check as described above; set target power factor only but let all of the compensation outputs set as zero outputs and switch the controller into the manual state. After observed period, according registered negative minimums of the RC / RL reserves you can size the compensation system capacity.



When you use an instrument model equipped with built-in real time circuit for compensation reserve measurement you will get the reserve minimums and maximums including their time stamps too.

## 5. Computer Controlled Operation

Monitoring the currently measured values and the instrument setup can be done using a remote computer connected to the instrument via a communication link. Such operation allows you to use all the setup options of the instrument, which it is not possible from the panel of the instrument.

Following chapters describe instrument communication links from the hardware point of view only. The detailed description of ENVIS program can be found in the program manual.

### 5.1 Communication Interface

#### 5.1.1 RS-485 Interface

The link is galvanically isolated from other circuits of the instrument. Use terminals **A** (No. 41), **B** (42) and **GND** (43).

For proper link operation, the communication address, baudrate and protocol (parameter groups 85 and 86) must be set.

##### 5.1.1.1 Communication Cable

For common applications (cable length up to 100 metres, communication rate up to 9,600 Bd) the selection of the right cable is not crucial. It is practically possible to use any shielded cable with two pairs of wires and to connect the shielding with the Protective Earth wire in a single point.

With cable lengths over 100 metres or with communication rates over 20 kilobits per second, it is convenient to use a special shielded communication cable with twisted pairs and a defined wave impedance (usually about 100 Ohm). Use one pair for the **A** and **B** signals and the second pair for the **GND** signal.

##### 5.1.1.2 Terminating Resistors

The RS-485 interface requires impedance termination of the final nodes by installation of terminating resistors, especially at high communication rates and long distances. Terminating resistors are only installed on the final points of the link (for example one on the PC and another on the remotest instrument). They are connected between terminals **A** and **B**. Typical value of the terminating resistor is 330 Ohm.

#### 5.1.2 Ethernet (IEEE802.3) Interface

Using this interface the instruments can be connected directly to the local computer network (LAN). Instruments with this interface are equipped with a corresponding connector RJ-45 with eight signals (in accordance with ISO 8877), a physical layer corresponds to 10/100 BASE-T.

Type and maximum length of the required cable must respond to IEEE 802.3.

Each instrument must have a different IP-address, preset during the installation. Physically, the interface is created with embedded Ethernet-to-serial converter ES01. Setup of the module can be found in application handbook *ES01 Embedded Ethernet to Serial Link Converter* that is available on [www.kmbsystems.eu](http://www.kmbsystems.eu).

## 5.2 Communication Protocols

### 5.2.1 KMB Communications Protocol

This manufacturer proprietary protocol is used for communication with the ENVIS-DAQ or the ENVIS-Online program.

### 5.2.2 Modbus Communications Protocol

For the chance of easier integration of the instrument to the user's program, the instrument is also equipped with the Modbus-RTU / Modbus-TCP communications protocol. A detailed description of the communications records can be found in an appropriate manual.

## 5.3 The ENVIS Program

The ENVIS set of programs is used to set up the instruments, downloading actual measured data and to data visualization and archiving on a supervising PC. Detailed operation description can be found in manuals of the programs ( [www.kmbystems.eu](http://www.kmbystems.eu) ).

### Measured Data Visualization Examples

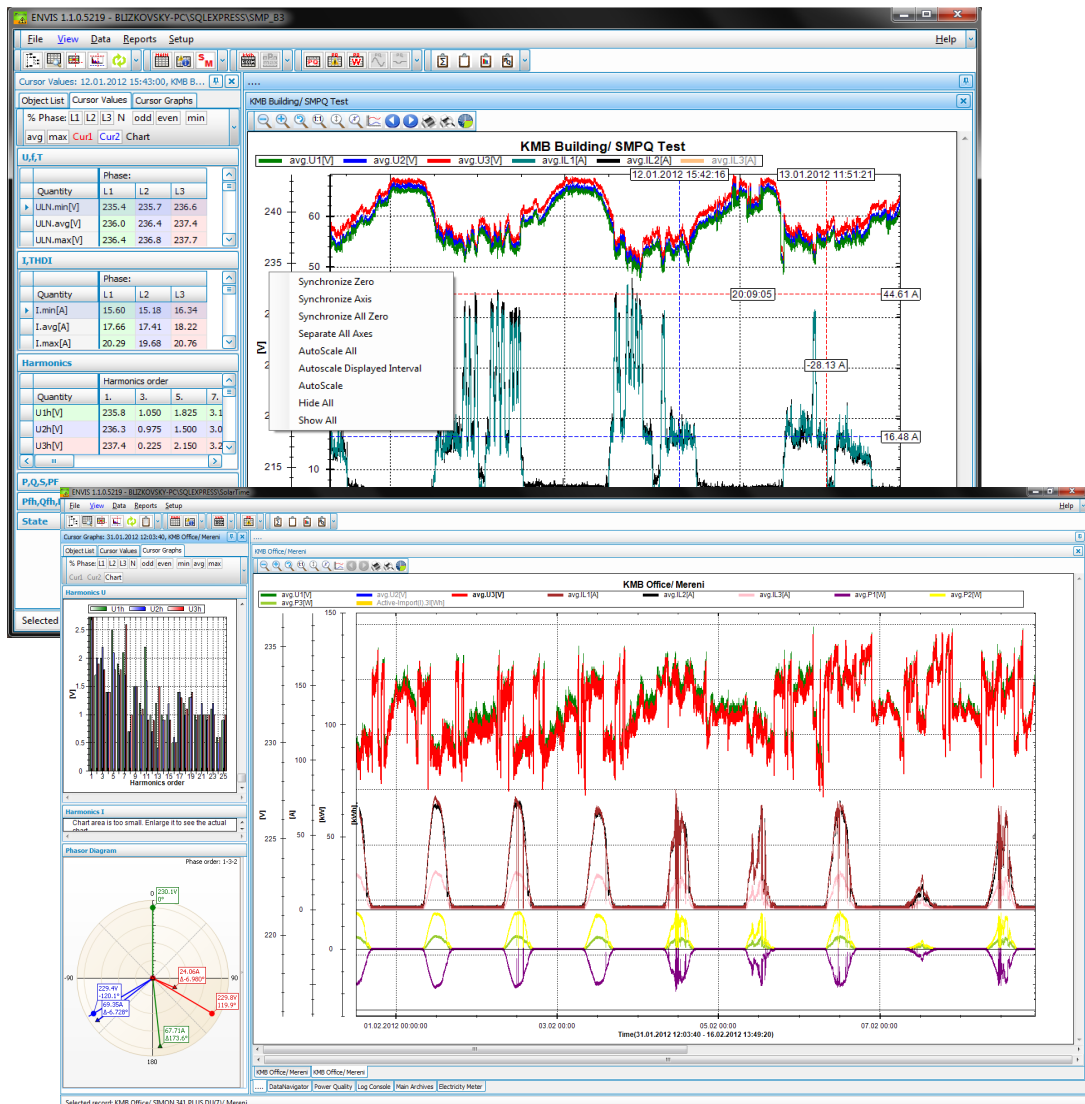

# 6. Examples of Connections

## NOVAR 2418 Typical Installation TN-Network, Direct Star ("3Y") Connection 18 Contactor Sections

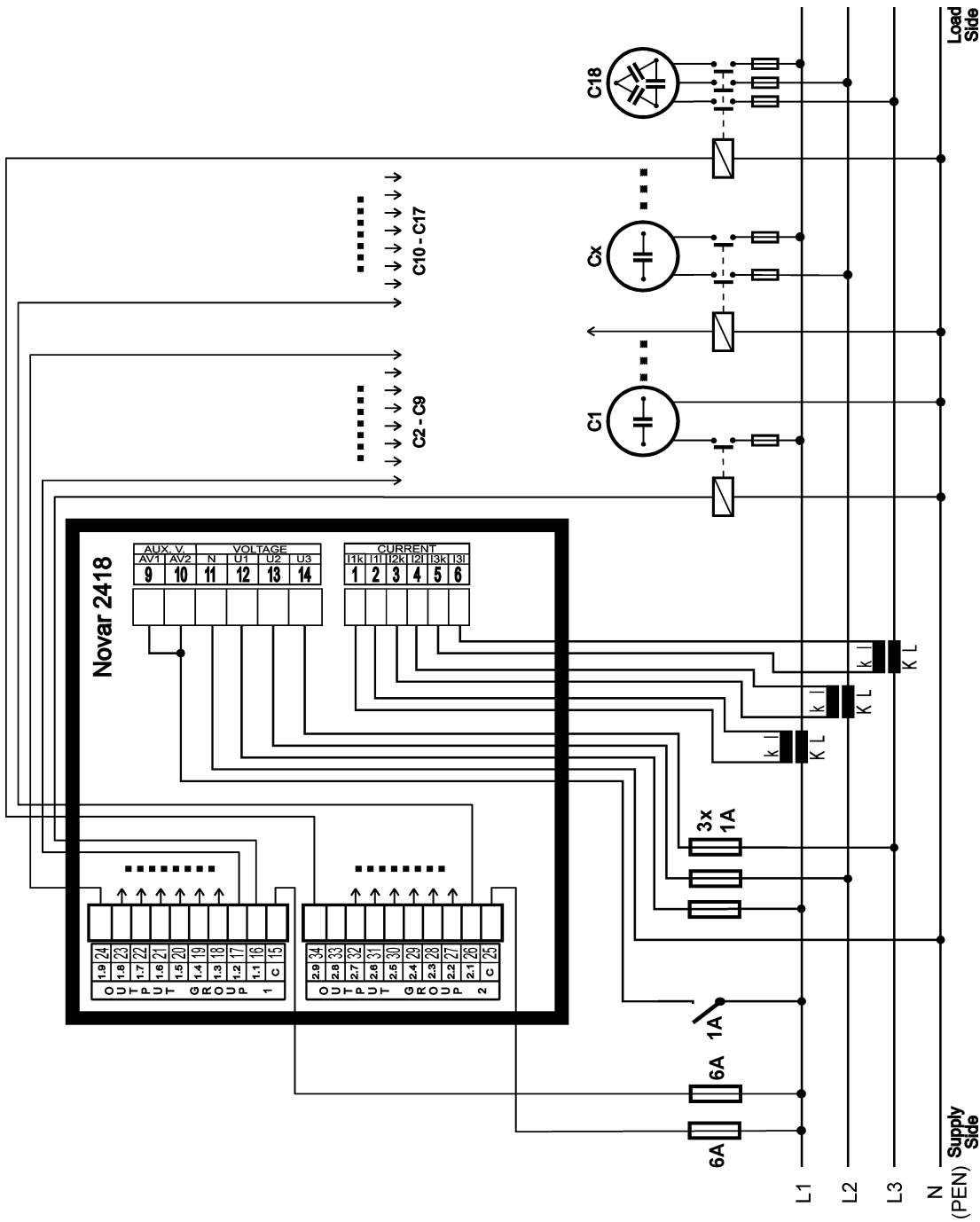

# NOVAR 2416 Typical Installation

## TN-Network, Direct Star ("3Y") Connection

### 14 Contactor Sections

### 2<sup>nd</sup> Tariff Control, Fan, Alarm

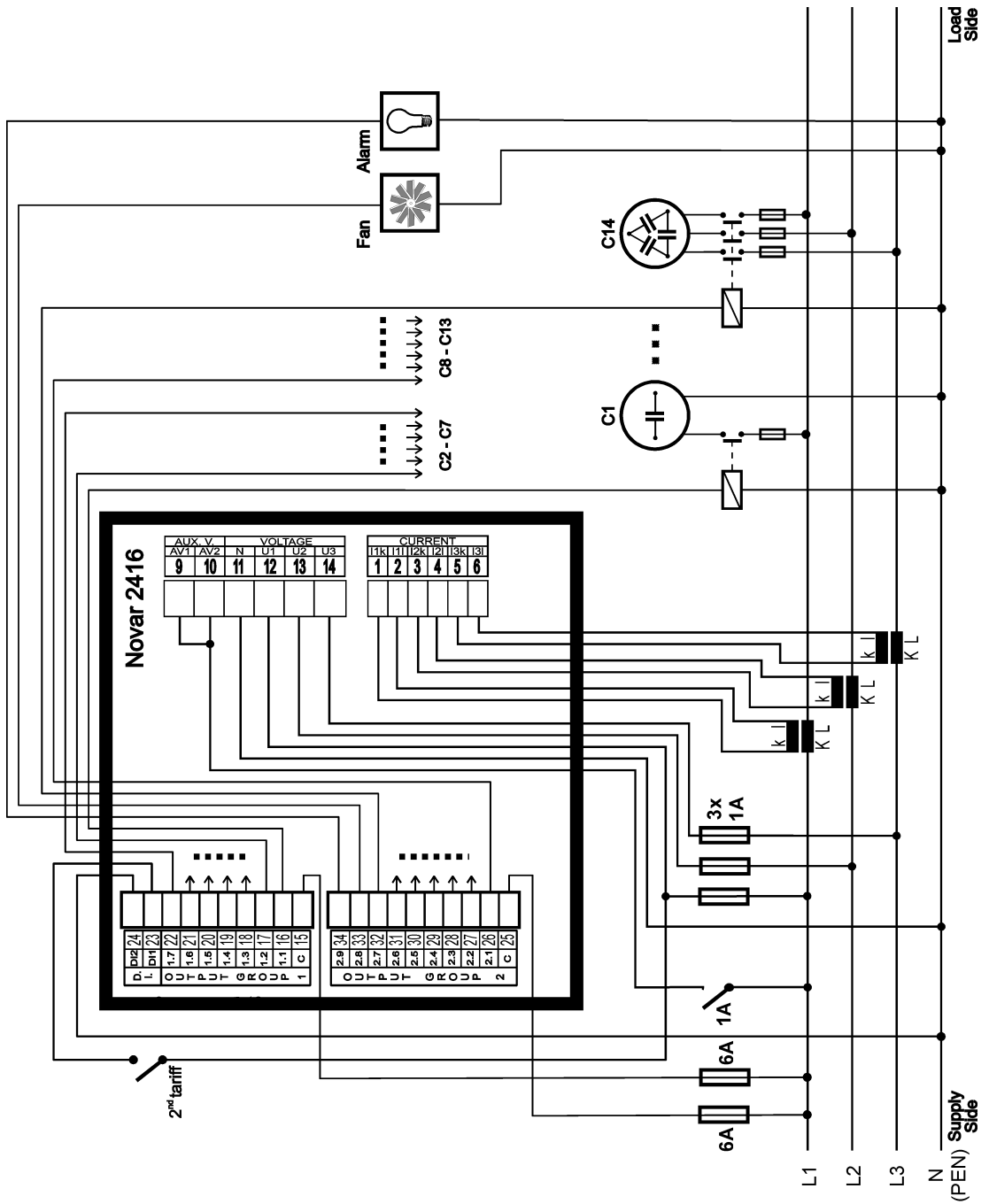

# NOVAR 24xx – Measured Signal Connection Examples

*TN Network  
Direct Star (“3Y”) Connection*

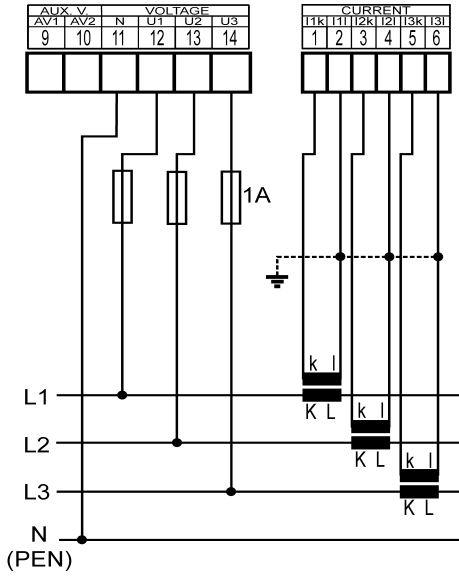

*IT Network  
Direct Delta (“3D”) Connection*

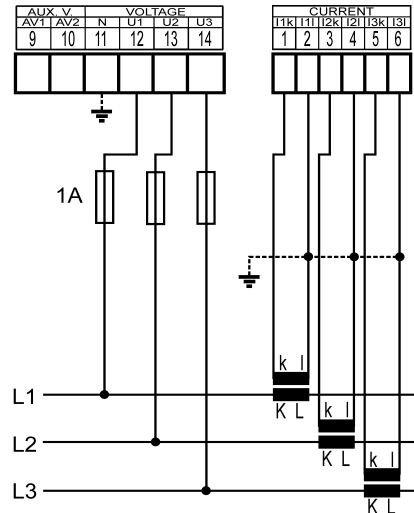

*IT Network  
Direct Aron (“3A”) Connection*

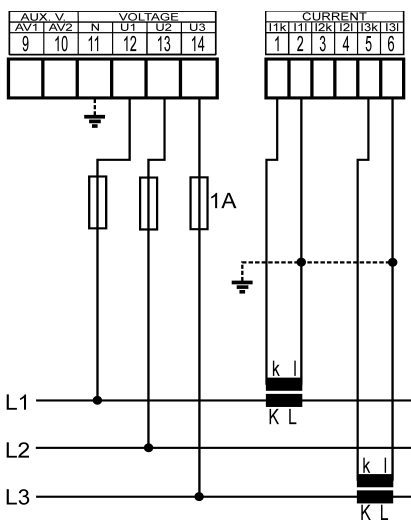

*TN Network  
Star (“3Y”) Connection via VT*

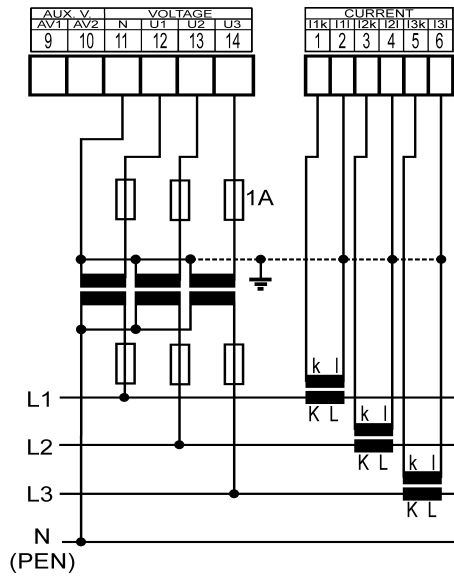

*IT Network  
Delta ("3D") Connection via VT  
(VT to Line-to-Neutral Primary Voltage)*

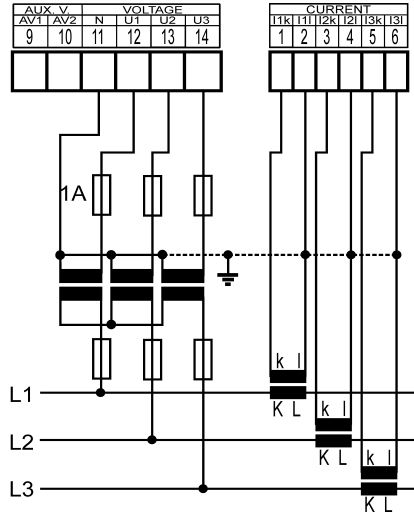

*IT Network  
Delta ("3D") Connection via VT  
(VT to Line-to-Line Primary Voltage)*

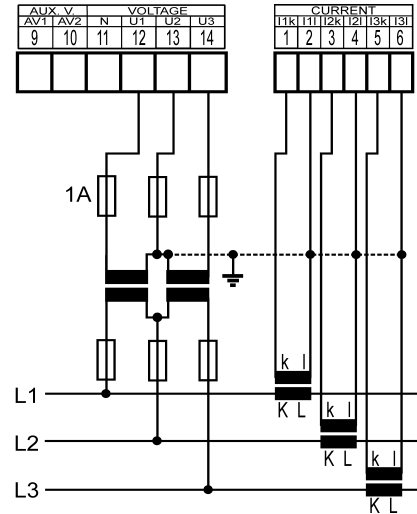

## NOVAR 24xx – Power Supply Options

*Line-to-Neutral Voltage  
AC Power Supply*

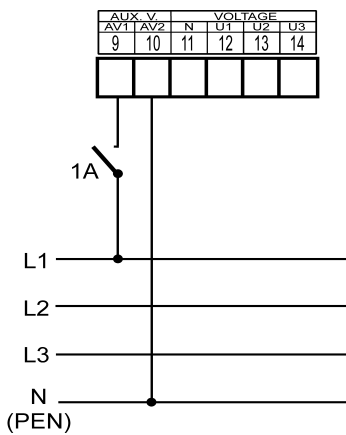

*Line-to-Line Voltage  
AC Power Supply*

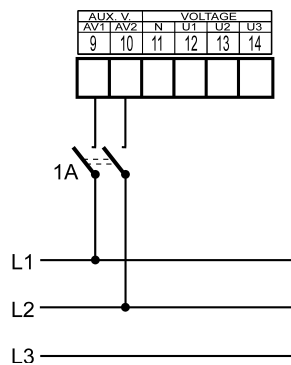

*DC Power Supply*

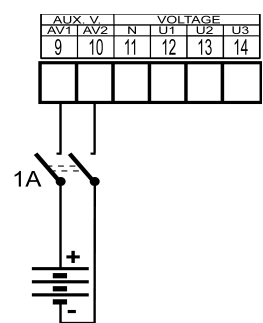

## NOVAR 2418 4 – RS485 Remote Communication Connection

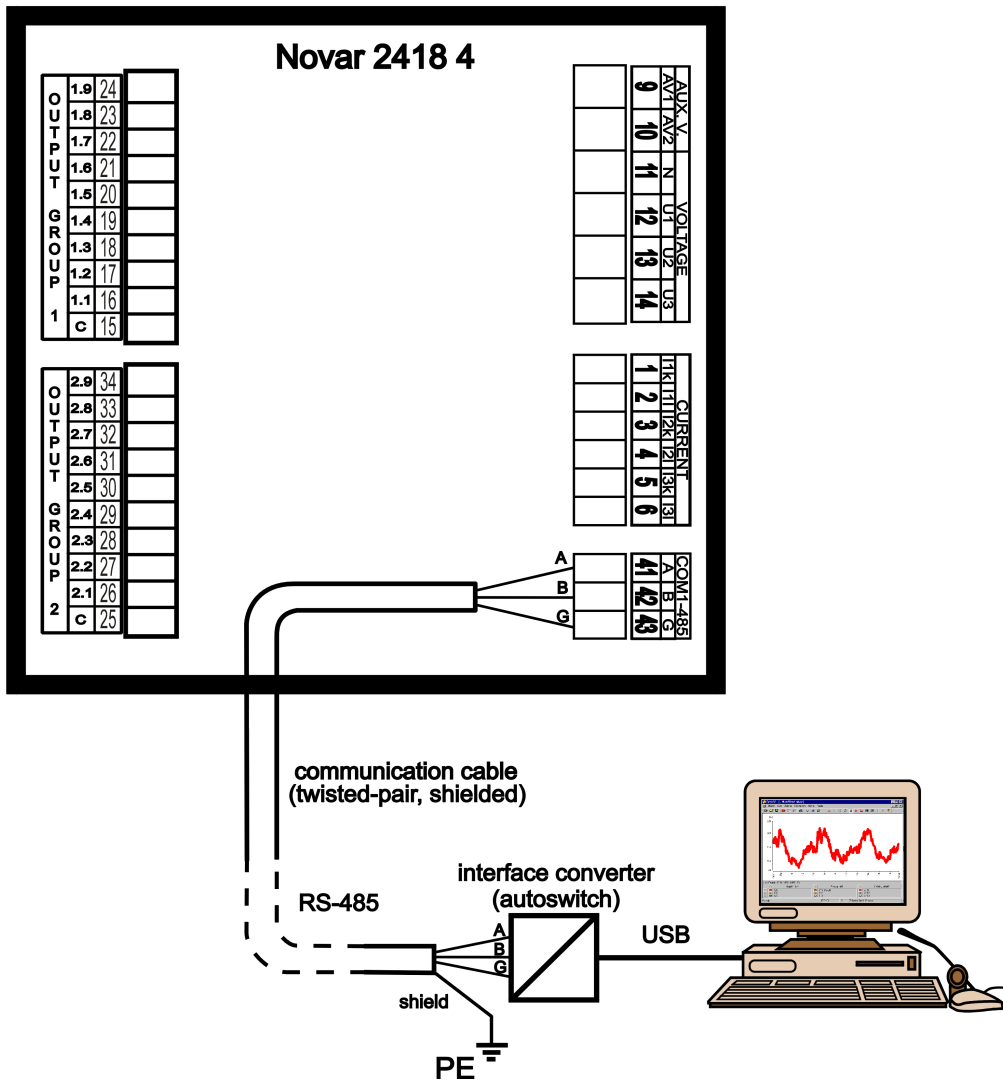



## 7. Manufactured Models and Marking

	<b>NOVAR</b>	<b>24</b>	<b>18</b>	<b>E</b>
<b>Instrument class</b>	NOVAR = Automatic power factor controller			
<b>NOVAR model</b>	24 = 3-phase, panel 144×144mm, segment LCD			
<b>Outputs</b>	07 = 7 relay outputs + 1 digital input 09 = 9 relay outputs 16 = 16 relay outputs + 1 digital input 18 = 18 relay outputs			
<b>Remote communication interface</b>	N = without remote communication 4 = RS-485 E = Ethernet 10BaseT			

## 8. Technical Specifications

Auxiliary Voltage	
range	$75 \div 500 V_{AC} / 43 \div 450 \text{ Hz}$ or $90 \div 600 V_{DC}$
power	10 VA / 8 W
overvoltage category for voltage up to 300V <sub>AC</sub> for voltage over 300V <sub>AC</sub>	III II
pollution degree	2
connection	galvanically isolated, polarity free

Measured Voltage, Current, Temperature	
Frequency	
$f_{NOM}$ – nominal frequency	50 / 60 Hz
measuring range	$42.5 \div 57.5 / 51 \div 69 \text{ Hz}$
Voltage	
measuring range & cath. ( terminals U1, U2, U3 towards N, phase / line )	$5 \div 480 V_{AC} / 8 \div 830 V_{AC}$ 300V CAT III
permanent overload (IEC 258)	600 V <sub>AC</sub> ( U <sub>L-N</sub> )
peak overload	1500 V <sub>AC</sub> ( U <sub>L-N</sub> ) / 1 second
$U_n$ (U <sub>din</sub> )– rated voltage (declared input voltage)	$57.7 / 100 \div 400 / 693 V_{AC}$
burden power ( impedance)	< 0.05 VA ( Ri = 6 M $\Omega$ )
Current	
measuring range & cath.	$0.005 \div 6 A_{AC}$ 150V CAT III
permanent overload (IEC 258)	7.5 A <sub>AC</sub>
peak overload - for 1 second, maximum repetition frequency > 5 minutes	70 A <sub>AC</sub>
$I_n$ – rated current	5 A <sub>AC</sub> / 1 A <sub>AC</sub>
burden power ( impedance)	< 0.5 VA ( Ri < 10 m $\Omega$ )
Temperature (internal temperature sensor)	
internal temperature sensor measuring range measurement uncertainty	- 40 $\div$ 80 °C $\pm 2$ °C
external Pt100 temperature sensor analog input measuring range measurement uncertainty	- 50 $\div$ 150 °C $\pm 2$ °C ( three-wire connection )

Function Characteristics according EN 61557-12				
Measuring Voltage Input Types : „400“ & $U_n = 200 \div 400 \text{ V}$ ; „100“ & $U_n = 50 \div 100 \text{ V}$				
$I_n = 5 \text{ A}$ , $f_{\text{NOM}} = 50 / 60 \text{ Hz}$				
Symbol	Function	Class	Measuring range	Notes
<b>P</b>	total effective power	0.5	0 ÷ 8640 W	1)
<b>QA, QV</b>	total reactive power	1	0 ÷ 8640 var	
<b>SA, SV</b>	total apparent power	0.5	0 ÷ 8640 VA	
<b>Ea</b>	total active energy	0.5	0 ÷ 8640 Wh	1)
<b>ErA, ErV</b>	total reactive energy	1	0 ÷ 8640 varh	
<b>EapA, EapV</b>	total apparent energy	0.5	0 ÷ 8640 VA	
<b>f</b>	frequency	0.05	42.5 ÷ 69 Hz	
<b>I</b>	phase current	0.5	0.005 ÷ 6 AAC	
<b>IN</b>	neutral current measured	–	–	
<b>INc</b>	neutral current calculated	0.5	0.005 ÷ 18 AAC	3)
<b>ULN</b>	line-to-neutral voltage	0.5	5 ÷ 480 VAC	
<b>ULL</b>	line-to-line voltage	0.5	8 ÷ 830 VAC	
<b>PFA, PFV</b>	power factor	0.5	0 ÷ 1	
<b>Pst, PIt</b>	flicker	–	–	
<b>Udip</b>	voltage dips	–	–	
<b>Uswl</b>	voltage swells	–	–	
<b>Utr</b>	transients overvoltage	–	–	
<b>Uint</b>	voltage interruption	–	–	
<b>Unba</b>	voltage unbalance (amp.)	–	–	
<b>Unb</b>	voltage unbalance (ph.&amp;.)	1	0 ÷ 10 %	3)
<b>Uh</b>	voltage harmonics	2	up to 40 <sup>th</sup> order	2)
<b>THDu</b>	voltage total harmonic distortion (rel. to fund.)	2	0 ÷ 20 %	
<b>THD-Ru</b>	voltage total harmonic distortion (rel. to RMS)	–	–	
<b>Ih</b>	current harmonics	2	up to 40 <sup>th</sup> order	2)
<b>THDi</b>	current total harmonic distortion (rel. to fund.)	2	0 ÷ 200 %	
<b>THD-Ri</b>	voltage total harmonic distortion (rel. to RMS)	–	–	
<b>Msv</b>	mains signalling voltage	–	–	

Notes : 1) ... class 1 for  $I_n = 1 \text{ A}$

2) ... classification according EN61000-4-7 ed.2

3) ... value available via communication link only, not displayed

Instrument Characteristics according EN 61557-12	
power quality assessment function	–
classification according to par. 4.3	
direct voltage connection	SD
voltage connection via VT	SS
temperature according to par. 4.5.2.2	K55
humidity + altitude according to par. 4.5.2.3	< 95 % - noncondensation conditions < 3000 m
active power/energy function performance class	0.5

Outputs & Digital Input	
<b>Relays</b>	
type	N.O. contact
load rating	250 V <sub>AC</sub> / 4 A 30 V <sub>DC</sub> / 4 A
<b>Transistors</b>	
type	Opto-MOS
load rating	max. 100 V <sub>DC</sub> / 100 mA
<b>Digital Input</b>	
type	optoisolated
maximum voltage	265 V <sub>AC</sub> ( 460 V <sub>AC</sub> for overvoltage category II )
voltage for "logical 1"	>= 90 V <sub>AC</sub>
voltage for "logical 0"	<= 30 V <sub>AC</sub>
input power ( impedance )	< 0.4 VA ( Ri = 200 kΩ )

<b>Other Specifications</b>	
instrument classification	class B in compliance with IEC 61000-4-30 ed. 2
meas. voltage loss & external alarm response time (output disconnect.)	<= 20 ms
operational temperature :	- 20 to 60°C
storage temperature	- 40 to 80°C
operational and storage humidity	< 95 % - non-condensable environment
EMC – immunity	EN 61000 – 4 - 2 ( 4kV / 8kV ) EN 61000 – 4 - 3 ( 10 V/m up to 1 GHz ) EN 61000 – 4 - 4 ( 2 kV ) EN 61000 – 4 - 5 ( 2 kV ) EN 61000 – 4 - 6 ( 3 V ) EN 61000 – 4 - 11 ( 5 periods )
EMC – emissions	EN 55011, class A EN 55022, class A (not for home use )
remote communication port (option)	RS-485 or Ethernet 10/100 Base-T KMB / Modbus-RTU / Modbus-TCP protocol support
display	backlit LCD-FSTN, segment
protection class front panel back panel	IP 40 ( IP 54 with cover sheeting ) IP 20
dimensions front panel built-in depth installation cutout	144 x 144 mm 60 mm 138 <sup>+1</sup> x 138 <sup>+1</sup> mm
mass	max. 0.5 kg

## 9. Maintenance, Service

The NOVAR 24xx instruments do not require any maintenance in their operation. For reliable operation it is only necessary to meet the operating conditions specified and not expose the instrument to violent handling and contact with water or chemicals which could cause mechanical damage.

In the case of failure or a breakdown of the product, you should contact the supplier at their address:

Supplier :

Manufacturer :

KMB systems, s.r.o.

Dr. M. Horákové 559

460 06 LIBEREC 7

Czech Republic

Phone+420 485 130 314

Fax +420 482 736 896

E-mail: [kmb@kmb.cz](mailto:kmb@kmb.cz)

Website: [www.kmbsystems.eu](http://www.kmbsystems.eu)

The product must be in proper packaging to prevent damage during transit. A description of the problem or its symptoms must be delivered together with the product.

If a warranty repair is claimed, the warranty certificate must be sent in. In case of an out-of-warranty repair you have to enclose an order for the repair.

### Warranty Certificate

Warranty period of 24 months from the date of purchase is provided for the instrument, however, no longer than 30 months from the day of dispatch from the manufacturer. Problems in the warranty period, provably because of faulty workmanship, design or inconvenient material, will be repaired free of charge by the manufacturer or an authorized servicing organization.

The warranty ceases even within the warranty period if the user makes unauthorized modifications or changes to the instrument, connects it to out-of-range quantities, if the instrument is damaged due to ineligible or improper handling by the user, or when it is operated in contradiction with the technical specifications presented.

Type of product: **NOVAR**..... Serial number.....

Date of dispatch: ..... Final quality inspection: .....

Manufacturer's seal:

Date of purchase: ..... Supplier's seal: